

Planar QE Series User Manual



Planar utilizes HDMI® standards in this product.

The terms HDMI, HDMI High-Definition Multimedia Interface, HDMI Trade dress and the HDMI Logos are trademarks or registered trademarks of HDMI Licensing Administrator, Inc.

Copyright © 01/01/2020 by Planar Systems, Inc. All rights reserved.

Contents of this publication may not be reproduced in any form without permission of Planar Systems, Inc.

Trademark Credits

Windows™ is a trademark of Microsoft Corp.

All other companies are trademarks or registered trademarks of their respective companies.

Disclaimer

The information contained in this document is subject to change without notice. Planar Systems, Inc. makes no warranty of any kind with regard to this material. While every precaution has been taken in the preparation of this manual, the Company shall not be liable for errors or omissions contained herein or for incidental or consequential damages in connection with the furnishing, performance, or use of this material.

Warranty and Service Plans

Planar warranty and service plans will help you maximize your investment by providing great support, display uptime, and performance optimization. From post-sale technical support to a full suite of depot services, our services are performed by trained Planar employees. When you purchase a Planar product, you get more than a display, you get the service and support you need to maximize your investment. To find the latest warranty and service information regarding your Planar product, please visit <http://www.planar.com/support>

Part Number: 020-1320-01A

Discontinued

Contents

Introduction	1
Safety Information	2
Safety Precautions	2
Recommended Usage	4
Mounting with a VESA Mount	6
Cleaning the Display	6
Package Contents	7
Standard Inputs	9
Planar QE Series Displays	9
Installing the Displays	10
Before You Begin	10
Supported Graphics Cards	11
Operating the Display	12
OSD Keypad	12
Remote Control Receiver	13
LED Indicators	14
Using the Display in Portrait Mode	14
Using the Display in Flat or Tilted Orientation	14
Using the Remote Control	15
IR Command Protocol	16
Turning the Display On	19
Turning the Display Off	19

Adjusting the Volume20

Selecting Layouts and Input Sources.....20

Navigating Through the Menus.....21

Using the Touch Screen45

Planar QE Series Remote Monitoring Software46

Remote Monitoring Home.....46

Remote Monitoring System Information46

Remote Monitoring Inputs and Views.....47

Remote Monitoring Audio.....48

Remote Monitoring Panel Brightness and Power49

Remote Monitoring Notifications50

Remote Monitoring System Settings.....51

Remote Monitoring Access Control52

External Control53

Signal Compatibility54

Color Subsampling Support57

Specifications.....58

Dimensions60

QE755060

QE7550 Touch61

QE865062

QE8650 Touch63

QE985064

QE9850 Touch65

Discontinued

Troubleshooting During Installation..... 66

 Error Codes 66

 Symptoms, Possible Causes and Solutions 67

Accessing Planar’s Technical Support Website..... 70

Discontinued

Discontinued

Introduction

Offered in sizes ranging from 75" to 98", the Planar® QE Series is a line of UltraHD resolution (3840 x 2160) LCD displays that are ideal for applications ranging from dynamic digital signage to collaborative meeting spaces.

With cutting edge 4K @ 60Hz support through DisplayPort 1.2 and HDMI 2.0, single or quad-source viewing, and multiple display control options, the Planar QE Series is also ideal for collaborative meeting spaces when paired with a compatible source. For those seeking to collaborate or annotate using a large viewing area, multi-touch models are also available. Each touch display ships with Planar® TouchMark™, the premier collaboration solution for annotation and whiteboarding needs.

Featuring a logo-free bezel, the Planar QE Series is perfect for use in retail stores, restaurants, medical offices, corporate meeting areas, huddle rooms and hospitality. Designed for up to 24 x 7 operation in commercial installations, the Planar QE Series is backed by Planar's industry-leading 3-year warranty. Featuring LED backlight technology, the Planar QE Series displays operate at lower power, reducing total cost of ownership.

Features include:

- Sizes ranging from 75" to 98"
- Ultra HD resolution (3840 x 2160) LCD displays
- Cutting edge video performance supporting up to 4K @ 60Hz
- Fully integrated multi-touch models available
- Fanless, whisper-quiet

Discontinued

Safety Information

Before using the Planar QE Series, please read this manual thoroughly to help protect against damage to property, and to ensure personal safety.

- Be sure to observe the following instructions.
- For your safety, be sure to observe ALL the warnings detailed in this manual.
- For installation or adjustment, please follow this manual's instructions, and refer all servicing to qualified service personnel.

Safety Precautions

- **If water is spilled or objects are dropped inside the display, remove the power plug from the outlet immediately.** Failure to do so may result in fire or electrical shock. Contact your dealer for inspection.
- **If the display is dropped or the chassis is damaged, remove the power plug from the outlet immediately.** Failure to do so may result in fire or electrical shock. Contact your dealer for inspection.

WARNING! Wall mounts must be secure.

- **If the display is hung on a wall, the wall must be strong enough to hold it.** Simply mounting it to wallboard or wall paneling won't be adequate or safe.

Caution: The screen could be damaged by heavy pressure.

- **Slight pressure on the LCD will cause distortion of the image.** Heavier pressure will cause permanent damage. Displays should be mounted where viewers cannot touch the screen or insert small objects in the openings that will create hazards by contacting bare conductive parts.

Caution: The front polarizer is soft and subject to scratches from sharp objects.

- **The polarizer is a thin sheet of film laminated to the outside layer of glass on the LCD screen.** Take care when handling items near the screen.
- **If the power cord or plug is damaged or becomes hot, turn off the main power switch of the display. Make sure the power plug has cooled down and remove the power plug from the outlet.** If the display is still used in this condition, it may cause a fire or an electrical shock. Contact your dealer for a replacement.

Important Safety Instructions

- 1** Read these instructions.
- 2** Keep these instructions.
- 3** Heed all warnings.
- 4** Follow all instructions.
- 5** Do not use the display near water.
- 6** Clean the LCD screens with an LCD screen cleaner or LCD wipes.
- 7** Do not install near any heat sources such as radiators, heat registers, stoves or other apparatus (including amplifiers) that produce heat.
- 8** Do not defeat the safety purpose of the polarized or grounding type plug. A polarized plug has two blades with one wider than the other. A grounding type plug has two blades and a third grounding prong. The wide blade or the third prong is provided for your safety. When the provided plug does not fit into your outlet, consult an electrician for the replacement of the obsolete outlet.
- 9** Protect the power cord from being walked on or pinched, particularly at plugs, convenience receptacles and the point where they exit from any of the displays.
- 10** Only use the attachments/accessories specified by the manufacturer.
- 11** Unplug all displays during lightning storms or when unused for long periods of time.
- 12** You must follow all National Electrical Code regulations. In addition, be aware of local codes and ordinances when installing your system.
- 13** Refer all servicing to qualified service personnel. Servicing is required when any of the displays have been damaged in any way. For example, if the AC power cord or plug is damaged, liquid has been spilled or objects have fallen into a display, the displays have been exposed to rain or moisture, do not operate normally or have been dropped.
- 14** Keep the packing material in case the equipment should ever need to be shipped.

Recommended Usage

In order to get the most out of your LCD, use the following recommended guidelines to optimize the display.

Burn-In Versus Temporary Image Retention

Burn-in causes the screen to retain an image essentially forever, with little or no way to correct the problem. Under normal use, an LCD will not experience burn-in, as plasma displays do, nor will it retain images in any way.

Normal use of an LCD is defined as displaying continuously changing video patterns or images. However, LCDs can experience *temporary* image retention when recommended usage guidelines are not followed.

What is Temporary Image Retention?

Temporary image retention (TIR) can occur when a static image is displayed continuously for extended periods of time (12 hours or longer). An electrical charge differential may build up between the electrodes of the liquid crystal, which causes a negative-color video image (color-inverted and brightness-inverted version of the previous image) to be retained when a new image is displayed. This behavior is true for any LCD device from any LCD manufacturer.

TIR is not covered under warranty. See standard warranty terms and conditions for details. Here are some guidelines to help you avoid TIR:

- Use the LCD to show a screen saver, moving images or still pictures that change regularly. When using high-contrast images, reposition the images frequently.
- Turn off the LCD when it is not in use. To use your source computer's Power Options Properties, set up your computer to turn off the display when not in use.

Warranty Coverage

The following models are warranted for **24 x 7** usage:

- 75": QE7550, QE7550T
- 86": QE8650, QE8650T
- 98": QE9850, QE9850T

Planar recommends turning off the power for **4 hours per day** for optimal performance.

For complete warranty details, please visit www.planar.com/warranty.

Important Waste Disposal Information

Please recycle or dispose of all electronic waste in accordance with local, state, and federal laws. Additional resources can be found online at <http://www.planar.com/about/green/>.

The crossed-out wheeled bin symbol is to notify consumers in areas subject to Waste Electrical and Electronic Equipment (WEEE) Directive 2012/19/EU that the product was placed on the market after August 13, 2005 and must not be disposed of with other waste. Separate collection and recycling of electronic waste at the time of disposal ensures that it is recycled in a manner that minimizes impacts to human health and the environment. For more information about the proper disposal of electronic waste, please contact your local authority, your household waste disposal service, or the seller from whom you purchased the product.



Normal Usage Guidelines

Normal use of the LCD is defined as operating in the open air to prevent heat buildup, and without direct or indirect heat sources such as lighting fixtures, heating ducts, or direct sunlight that can cause the displays to experience high operating temperatures. For all displays, do not block fans or ventilation openings. If the LCD display will be installed in a recessed area with an LCD surround or enclosure, ensure adequate openings are applied for proper air flow and ventilation.

It is up to the installer to ensure that display placement is changed, thermal shielding is provided and/or additional ventilation is provided to keep the display within its nominal operating parameters. Maximum ambient operating temperatures for the Planar QE Series are:

- 75", 86" and 98" Planar QE Series models: 0-35°C at up to 1500 meters and 0-30°C at up to 3000 meters

Cooling Requirements

For optimal performance, active cooling by the installer should be planned for when the ambient temperature anywhere in the wall is predicted to be above the specified ambient temperature for the display.

Mounting with a VESA Mount

VESA mounts are used to secure the Planar QE Series for display. The display can be installed using a variety of VESA mounts available through Planar. If you do not have a VESA mount and would like to purchase one, contact Planar.

If you purchased a VESA mount, you should have received a separate box with mounting supplies and an Installation manual. Follow these instructions carefully.

Keep in mind the following general installation guidelines:

- Screw length is crucial and will vary depending on the type of mount you use. Total screw length will include the penetration length plus the length required by the type of VESA mount in use.

Caution: Shorter screws will result in insufficient mounting strength and longer screws could puncture parts inside the display.

- Prior to installation, make sure you know where all of the mounting points are located.
- Follow all safety precautions outlined in the VESA Installation manual.
- Verify the parts received with the list shown in the VESA Installation manual.

Cleaning the Display

If dust has collected on the power plug, remove the plug from the outlet and clean off the dust. Dust build-up may cause a fire.



Remove the power plug before cleaning. Failure to do so may result in electrical shock or damage.

Keep the following points in mind when cleaning the surface of the display:

- When the surface of the display becomes dirty, wipe the surface lightly with a soft clean cloth.
- If the surface requires additional cleaning, use LCD screen cleaner or LCD wipes, which are available at most electronics stores.
- Do not let cleaner seep into the display, as it may cause electrical shock or damage.

Package Contents

Part	Description	Number Included	Picture
LCD display	One per box.	1	
AC power cord	Power cord.	1	
IR sensor	Used to receive signals from the remote control.	1	
USB drive	Contains the User Manual, touch drivers and USB-to-serial driver.	1	
USB cable	Connects to a PC for touch functionality (touch models only) and serial commands (all models).	1	

Part	Description	Number Included	Picture
Remote control	Used to control the display. 2 AA batteries are included but not installed.	1	
Planar® TouchMark™ Single License Key Card	Annotation and whiteboarding software (touch models only)	1	

Discontinued

Standard Inputs

Planar QE Series Displays

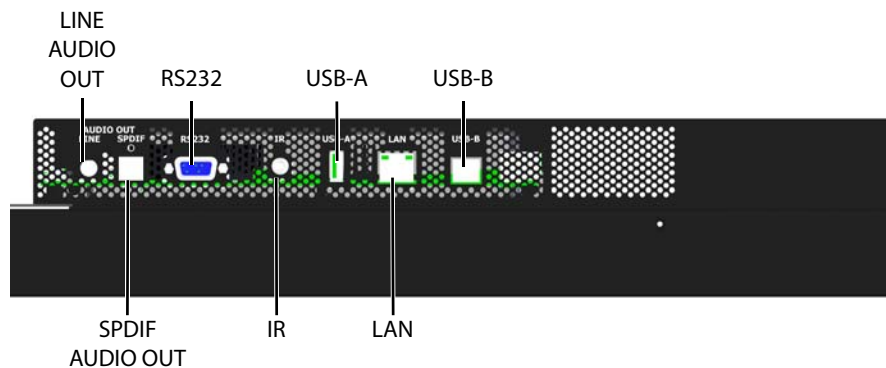
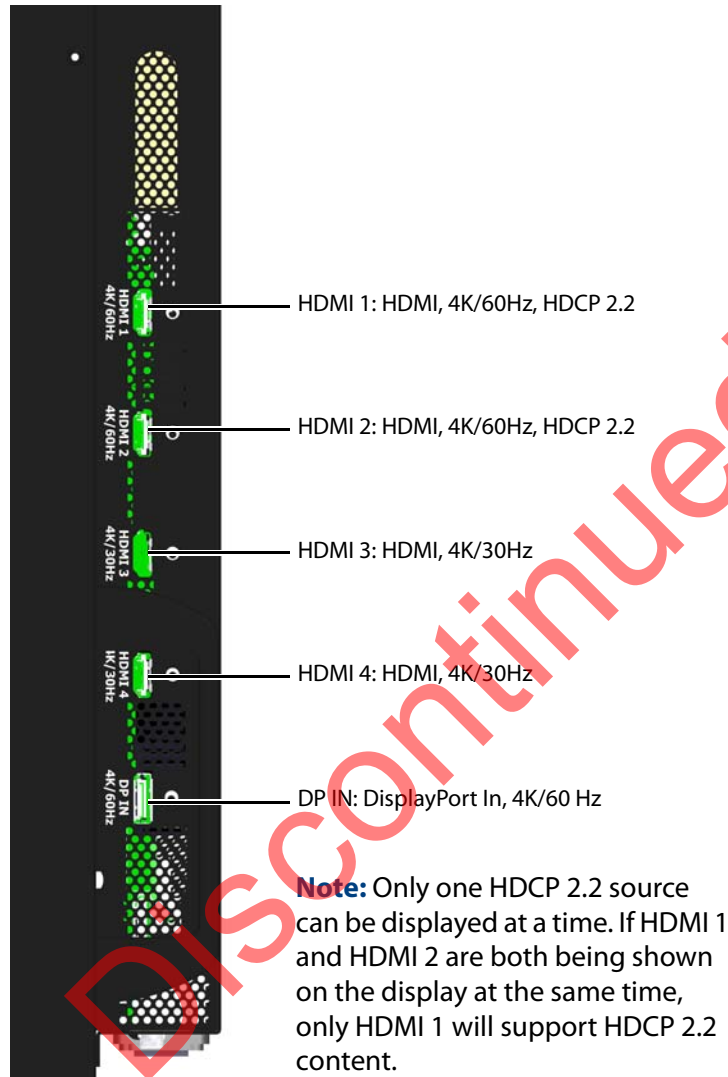

Installing the Displays

This section explains how to install your display. We suggest that you read the entire section before you attempt to install the unit.

Before You Begin

Make sure to have all the items in these lists before beginning to unpack and install your display(s).

Tools/Equipment List

Depending on your installation, you may need one or more of the following items:

- String/string level
- Digital/laser level
- Ladders/lift
- Back brace
- Stud finder (if hanging display on a wall)

Other Things You May Need

- LCD screen cleaner or LCD wipes - available at most electronics stores
- At least two very strong people to help lift units into place

Plan Your Installation

You should have a detailed plan of how the units are to be configured. The plan should include calculations for the following:

- Power (maximum of five units per 20A circuit for 115V operation)
- Cable runs
- Ventilation and cooling requirements
- If hanging display on a wall, location of studs in the wall

Prepare Your Installation Location

You should have prepared the area where you will install the unit. If custom enclosures are part of the installation, they must be fully designed to accommodate the installation of the displays, as well as the installed unit and ventilation and cooling requirements.

If your installation included a lot of construction or dust, it is **highly recommended** that you clean all of the screens after the wall installation and configuration are complete.

Cable Length Recommendations

Cable length performance may vary between different cables and sources. The recommended maximum DisplayPort length is 3m for DisplayPort 1.2 and 5m for DisplayPort 1.1. HDMI cable length is recommended as follows:

- 4K @ 50/60Hz: 5m maximum
- 4K @ 24/25/30Hz: 15m maximum
- 1080p @ 60Hz and lower resolutions: 30m maximum

Supported Graphics Cards

Planar QE Series displays support a variety of graphics cards from leading manufacturers, such as NVIDIA and AMD. In general, you should be looking for graphics cards that have the following features:

- Can output 3840 x 2160 at 24 Hz, 30 Hz or 60 Hz over a single DisplayPort or HDMI connection.
- Four-output graphics cards that can output synchronized (genlocked) 1920 x 1080 outputs at up to 60 Hz.
- Cards that support Planar's support timings, as listed in the following section "Signal Compatibility" on page 54.

Caution: Before you purchase a graphics card for your source, contact your Sales Representative to get the most current information on Planar's compatibility with leading graphics cards.

Discontinued

Operating the Display

OSD Keypad

The OSD keypad is located on the rear of the display.

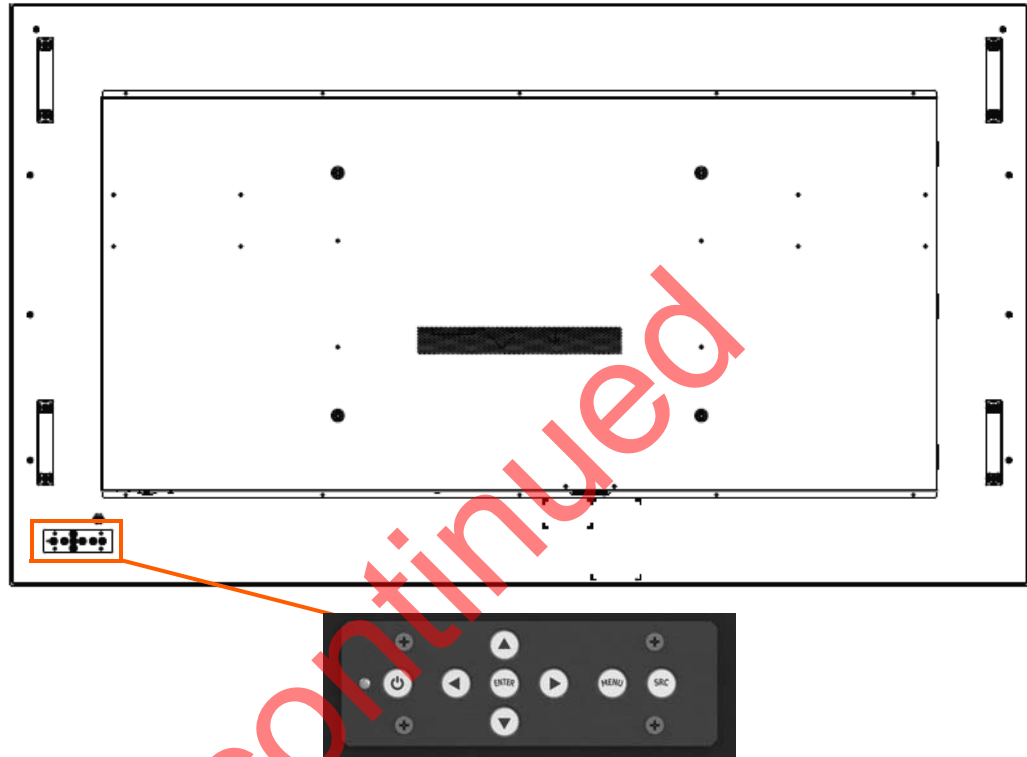

OSD Keypad Buttons

Key	Descriptions
Power	Power on/Power off
◀	Menu Left/Decrease value
▶	Menu Right/Increase value
▲	Menu Up/Increase volume
▼	Menu Down/Decrease volume
Menu	Menu/Exit
SRC	Source selection (toggle)

Remote Control Receiver

The remote control receiver is located near the keypad on the rear of the display. Use the IR extender cable for operating the remote from the front of the display.

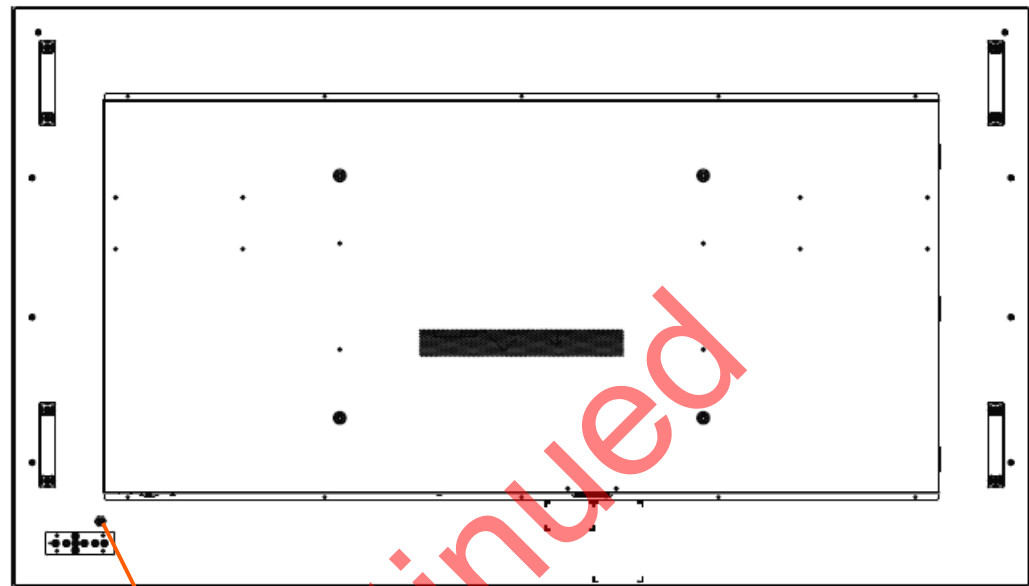

IR Sensor

Discontinued

LED Indicators

The LED indicator light is located on the rear of the display near the keypad. The following table explains what the different colors and blink patterns mean.

LED On

Power Status	Condition
Green	Standby mode
Amber	Full power mode
Green Flashing (1 Hz)	AC power on
Green Flashing (0.5 Hz)	Powering on from standby
Green Flashing (5 Hz)	Firmware updating
Amber Flashing (5 Hz)	Power supply failure
Green and Amber	Firmware update failure

Using the Display in Portrait Mode

When using the display in the portrait position and looking at the rear of the display, it should be rotated according to the arrow stickers on the back of the display. This will allow for proper ventilation. Then select the OSD rotation of landscape or portrait on the OSD menu (MAIN MENU > ADVANCED SETTINGS > MENUS AND MESSAGES > OSD ROTATION).

Caution: Improper ventilation may shorten the life of the display.

Using the Display in Flat or Tilted Orientation

The display is not recommended for use in flat orientation for tabletop, floor, or ceiling installations. LCD panels of this size are at risk of panel deflection, which can cause cosmetic sagging, brightness uniformity issues, a shortened life span, and malfunction of optional touch sensors. Installations where the display is tilted downward or upward at an angle may also be prone to these issues and are not recommended.

Using the Remote Control

Below is a picture of the remote control. See the following page for button descriptions and Hex codes.



IR Command Protocol

The Planar QE Series displays accept commands in the form of IR signals that conform to the NEC protocol. Each Planar QE Series remote control has an NEC control code associated with it. You can use these codes to program a third-party “universal” remote control to work with the Planar QE Series displays. These third-party products usually come with a computer software application for this purpose. For more information, consult the documentation provided with the remote control.

The IR control codes have the following characteristics:

- Each code consists of the following:
 - A leader pulse (a modulated pulse of 9 ms followed by a non-modulated pulse of 4.5 ms)
 - 16 address bits. The default address is 1785 (0x06F9, binary 00000110 11111001)
 - 16 data bits: eight (8) bits for the command followed by the logical inverse of the command
 - An end pulse (a modulated pulse of 0.56 ms, similar to the modulated pulse in the ‘0’ and ‘1’ bits). The end of the modulated pulse constitutes the end of the data transmission.
- The carrier frequency is 38 kHz, with the modulated pulses having a 33% duty cycle.
- Commands are sent at a maximum rate of 9 Hz.

For example, below is the NEC control code for the ON button of the Planar QE Series remote control (assuming the default address is used).

Hex	06	F9	01	FE
Binary	00000110	11111001	00000001	11111110
Function	Address Byte 1	Address Byte 2	Command	Command (Logical Inverse)

The following example shows the pulse train for this command.



Remote Control Button Name	Address	Data	NEC Data From Remote (Hex Code)	Description
ON	1785	1	0x06F901FE	Power on
OFF	1785	9	0x06F909F6	Power off
◀	1785	2	0x06F902FD	Not used
▶	1785	3	0x06F903FC	Not used
**	1785	6	0x06F906F9	Not used
PRESETS	1785	4	0x06F904FB	Not used
PRESET 1	1785	5	0x06F905FA	Not used
PRESET 2	1785	7	0x06F907F8	Not used
PRESET 3	1785	8	0x06F908F7	Not used
PRESET 4	1785	10	0x06F90AF5	Not used
1	1785	12	0x06F90CF3	Number button 1
2	1785	13	0x06F90DF2	Number button 2
3	1785	14	0x06F90EF1	Number button 3
4	1785	15	0x06F90FF0	Number button 4
5	1785	16	0x06F910EF	Number button 5
6	1785	17	0x06F911EE	Number button 6
7	1785	20	0x06F914EB	Number button 7
8	1785	25	0x06F919E6	Number button 8
9	1785	27	0x06F91BE4	Number button 9
0	1785	18	0x06F912ED	Number button 0
VOL +	1785	28	0x06F91CE3	Volume increase
VOL -	1785	33	0x06F921DE	Volume decrease
MUTE	1785	32	0x06F920DF	Audio mute
COLOR	1785	19	0x06F913EC	Not used
VIDEO WALL	1785	34	0x06F922DD	Not used
MISC	1785	11	0x06F90BF4	Opens the Image Information menu
MENU	1785	21	0x06F915EA	Opens the menu
PREV	1785	22	0x06F916E9	Returns to the previous menu
ENTER	1785	23	0x06F917E8	Selects the current menu item
UP	1785	26	0x06F91AE5	Navigate up
DOWN	1785	29	0x06F91DE2	Navigate left
LEFT	1785	31	0x06F91FE0	Navigate right
RIGHT	1785	24	0x06F918E7	Navigate down

Remote Control Button Name	Address	Data	NEC Data From Remote (Hex Code)	Description
TOP	1785	30	0x06F91EE1	Selects the top line in the current menu
ZONE 1	1785	35	0x06F923DC	Selects the input for Zone 1
ZONE 2	1785	36	0x06F924DB	Selects the input for Zone 2
ZONE 3	1785	38	0x06F926D9	Selects the input for Zone 3
ZONE 4	1785	39	0x06F927D8	Selects the input for Zone 4
PIP MODE	1785	37	0x06F925DA	Selects the Multi-Source View setting
PIP SWAP	1785	40	0x06F928D7	Not used
HDMI 1	1785	41	0x06F929D6	Selects HDMI 1 for the current zone
HDMI 2	1785	42	0x06F92AD5	Selects HDMI 2 for the current zone
HDMI 3	1785	43	0x06F92BD4	Selects HDMI 3 for the current zone
HDMI 4	1785	44	0x06F92CD3	Selects HDMI 4 for the current zone
DP	1785	45	0x06F92DD2	Selects DP for the current zone
DVI	1785	46	0x06F92ED1	Not used
VGA	1785	47	0x06F92FD0	Not used
OPS	1785	48	0x06F930CF	Not used

Locking the Keypad and IR Remote

You can lock the keypad and IR remote functionality on the display. To lock the keypad, go to Main Menu -> Advanced Settings -> System Settings and select Keypad Lock. To lock the IR remote, go to Main Menu -> Advanced Settings -> System Settings and select IR Remote Lock.

Unlocking the Keypad and IR Remote

To unlock the keypad, press the following keys on the keypad in the order listed: UP, UP, RIGHT, LEFT, DOWN. If the IR remote is unlocked, you can also unlock the keypad by using the IR remote to go to Main Menu -> Advanced Settings -> System Settings and uncheck Keypad Lock.

To unlock the IR remote, press the following keys on the IR remote in the order listed: UP, UP, RIGHT, LEFT, DOWN. If the keypad is unlocked, you can also unlock the IR remote by using the keypad to go to Main Menu -> Advanced Settings -> System Settings and uncheck IR Remote Lock.

Changing the IR Remote Code Set

The IR remote code set transmitted by the remote and accepted by the display can be configured. This is useful if there are multiple Planar displays and you would like each remote to work only with one of the displays. It can also be used if IR interference with another device, such as a DVD player, is occurring.

To change the IR code on the remote, use the following procedure:

- 1 Press and hold the CODE button on the remote control until the LED on the remote lights solid red (approximately five seconds).
- 2 Enter a new five-digit code between 00000 and 65535. Include leading zeros for codes with four or fewer digits; for example, enter 255 as 00255.
- 3 The LED turns off to confirm the code change. If you enter an invalid code, the LED flashes for three or four seconds. Try again, entering a valid code.

Note: The code must match the IR Remote ID Code setting. See page 41.

Turning the Display On

- 1 Insert the power cord into the display and into the power outlet.
- 2 Ensure the AC switch is set to “—”.
- 3 Press the ON button on the remote or the power button on the keypad.

Turning the Display Off

With the power on, press the OFF button on the remote or the power button on the keypad to put the LCD panel in a standby mode. To turn off power completely, turn the AC switch to “O” or disconnect the AC power cord from the power outlet.

Note: The display may automatically turn off the backlight or enter standby mode if no signal is present for a certain period of time. See the description of the Power Saving Mode setting on page 29 for more information.

Adjusting the Volume

- 1 Using the remote, press the VOL + or VOL - to increase or decrease the volume. You can also use the Up and Right keys to increase the volume, and the Down and Left keys to decrease the volume.
- 2 Press the MUTE button to temporarily turn off all sound. To restore the sound, press the MUTE button again.

Note: The analog audio out is variable. S/PDIF is fixed.

Selecting Layouts and Input Sources

With Planar QE Series, you can show one source at a time or multiple sources simultaneously. Multiple layout options are available and can be selected from the Inputs and Views Menu (see page 22). Once a layout has been designated, you can assign sources to each of the zones in the layout. The selection of sources must be made one at a time by assigning a current zone. To select the current zone, you can navigate through the on-screen menu (see page 22). Alternatively, you can use the remote or keypad as described next.

Remote

Press the Zone 1, Zone 2, Zone 3, or Zone 4 buttons on the remote. After selecting the desired zone, you can press the source button (DP, HDMI 1, HDMI 2, HDMI 3 or HDMI 4). This action will also select the active audio source.

For example, to change Zone 3 to HDMI 3, press the Zone 3 button and then press the HDMI 3 button.

Keypad

Press the SRC button. The input source will be toggled in the following order: HDMI 1, HDMI 2, HDMI 3, HDMI 4, DP.

Note: Sources will toggle through the current zone, or last zone to be modified. Current zones can only be re-assigned in the on-screen menu.

Navigating Through the Menu

- 1 With the power on, press MENU. The MAIN menu appears.

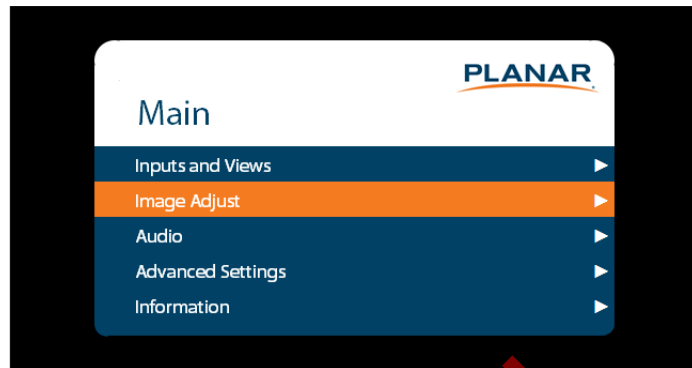

- 2 Within the menu, use ▲, ▼, ◀, ▶ and ENTER to navigate through the menus and adjust options.
- 3 Press PREV on the remote control, or MENU on the keypad, to return to the previous menu. To exit the menu system, press MENU on the remote control, or continue to press MENU on the keypad until the main menu is reached.

Discontinued

Inputs and Views Menu

This menu shows how the sources will be laid out on the screen based on the current Multi-Source View and Advanced Layouts selections.

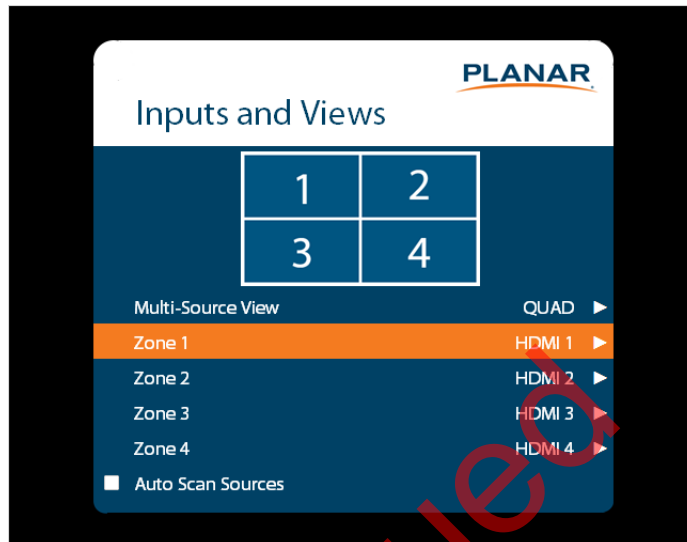

Multi-Source View

Select the Multi-Source View mode
Options: Single, Quad; **Default:** Single

Note: You can only use 4K/60Hz in Single mode.

Zone 1

Select the source displayed in Zone 1
Options: HDMI 1, HDMI 2, HDMI 3, HDMI 4, DP; **Default:** HDMI 1

Zone 2

Select the source displayed in Zone 2
Options: HDMI 1, HDMI 2, HDMI 3, HDMI 4, DP; **Default:** HDMI 2

Zone 3

Select the source displayed in Zone 3
Options: HDMI 1, HDMI 2, HDMI 3, HDMI 4, DP; **Default:** HDMI 3

Zone 4

Select the source displayed in Zone 4
Options: HDMI 1, HDMI 2, HDMI 3, HDMI 4, DP; **Default:** HDMI 4

Auto Scan Sources

Select whether the display will automatically scan for a valid source on any zone that currently does not have a source

Options: On, Off; **Default:** Off

Image Adjust Menu

This menu is used for making common image adjustments for the current zone.

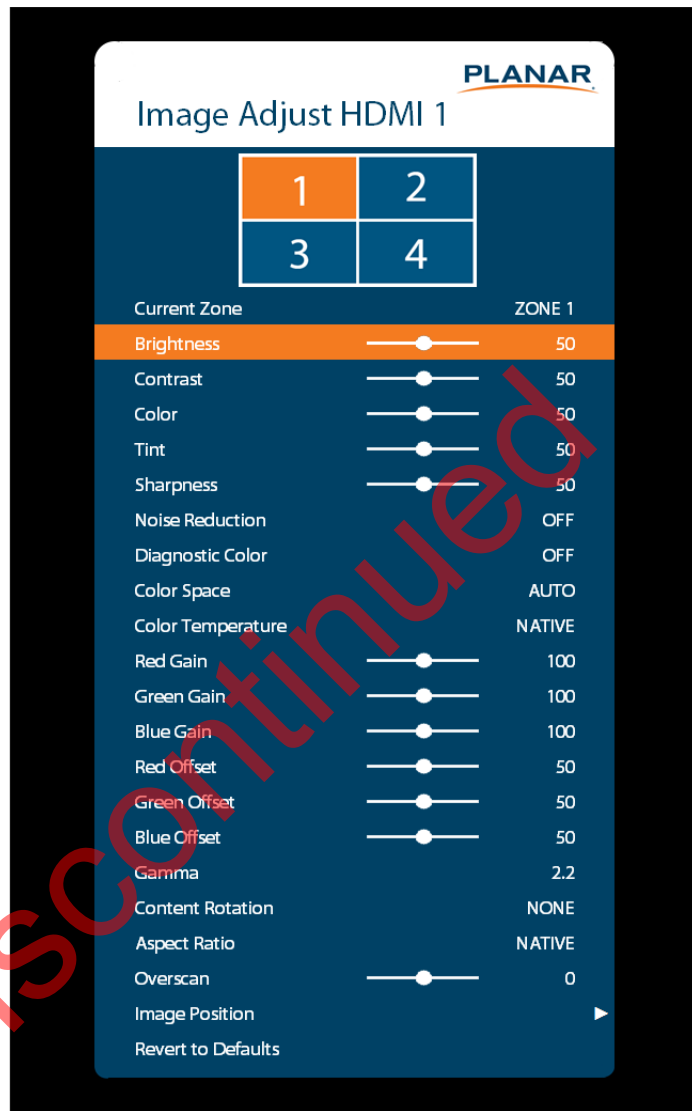

Current Zone

The zone that is currently being adjusted. All of the settings in this menu are saved per input. The zone's corresponding input source is shown in the title bar, and the graphic beneath that shows which zone is being adjusted in the current Multi-Source View mode and Advanced Layout setting (if applicable).

The current zone can be changed via the menu or by using the ZONE 1-4 keys on the remote control.

Note: Changing the Current Zone setting via the ZONE 1-4 keys also changes the Audio Select setting.

Brightness

Adjust the brightness value of the image
Range: 0~100; **Default:** 50

Contrast

Adjust the contrast of the image
Range: 0~100; **Default:** 50

Color

Adjust the saturation of the image
Range: 0~100; **Default:** 50

Tint

Adjust the hue of the image
Range: 0~100; **Default:** 50

Sharpness

Adjust the sharpness of the image. Higher numbers are sharper
Range: 0~10; **Default:** 5

Noise Reduction

Turn on noise reduction processing
Options: Off, Low, Medium, High; **Default:** Off

Diagnostic Color

Set the image to monochrome. This setting is for use in adjustments to a test pattern and is not stored.
Options: Off, Red, Green, Blue; **Default:** Off

Color Space

Set the color space of the image
Options: REC601, REC709, RGB, RGB Video, Auto; **Default:** Auto

Color Temperature

Set the color temperature of the image
Options: 3200K, 5500K, 6500K, 7500K, 9300K, Native; **Default:** Native

Red Gain

Adjust the red gain of the image
Range: 0~200; **Default:** 100

Green Gain

Adjust the green gain of the image
Range: 0~200; **Default:** 100

Blue Gain

Adjust the blue gain of the image
Range: 0~200; **Default:** 100

Red Offset

Adjust the red offset of the image
Range: 0~100; **Default:** 50

Green Offset

Adjust the green offset of the image
Range: 0~100; **Default:** 50

Blue Offset

Adjust the blue offset of the image
Range: 0~100; **Default:** 50

Gamma

Set the gamma of the image
Options: 1.5, 1.55, 1.6, 1.65, 1.7, 1.75, 1.8, 1.85, 1.9, 1.95, 2.0, 2.05, 2.1, 2.15, 2.2, 2.25, 2.3, 2.35, 2.4, 2.45, 2.5, 2.55, 2.6, 2.65, 2.7, 2.75, 2.8
Default: 2.2

Content Rotation

Rotate the image on the display
Options: None, 90, 180, 270; **Default:** None

Aspect Ratio

Set how the source is treated when the aspect ratio of the input is different than the aspect ratio of the zone it is in. If the image does not fill the zone completely, the extra margins are black.
Options: Auto, 16:9, 4:3, Fill Screen, Native, Letterbox; **Default:** Auto

Overscan

Set the percentage of the image to remove from each edge
Range: 0~20; **Default:** 0

Image Position

Move the image horizontally or vertically. The amount to move is measured in input pixels.
Range: -1000~1000; **Default:** 0

Revert to Defaults

Reset all settings in the Image Adjust menu to their factory defaults for the current zone only

Audio Menu

This menu enables you to make audio adjustments to the selected zone.

Note: Volume, Bass, Treble and Balance do not apply to the S/PDIF output.

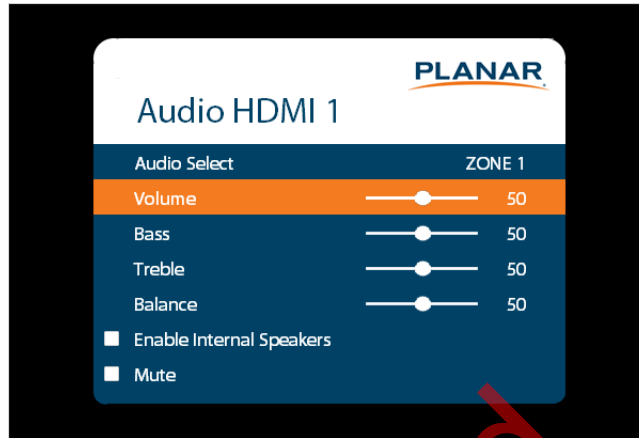

Audio Select

The zone that is currently being adjusted and whose audio is being played. The zone's corresponding input source is shown in the title bar.

Options: Zone 1, Zone 2, Zone 3, Zone 4; **Default:** Zone 1

Note: Changing the Audio Select setting via the ZONE 1-4 keys also changes the Current Zone setting.

Volume

Set the volume of the audio

Range: 0~100; **Default:** 50

Bass

Set the bass level

Range: 0~100; **Default:** 50

Note: This setting applies only to the internal speakers, and cannot be adjusted for the Line Out connector.

Treble

Set the treble level

Range: 0~100; **Default:** 50

Note: This setting applies only to the internal speakers, and cannot be adjusted for the Line Out connector.

Balance

Set the audio balance

Range: 0~100; **Default:** 50

**Enable Internal
Speakers**

Disable or enable the built-in speakers

Options: On, Off; **Default:** On

Mute

Mute or unmute the audio

Options: On or Off; **Default:** Off

Discontinued

Advanced Settings Menu

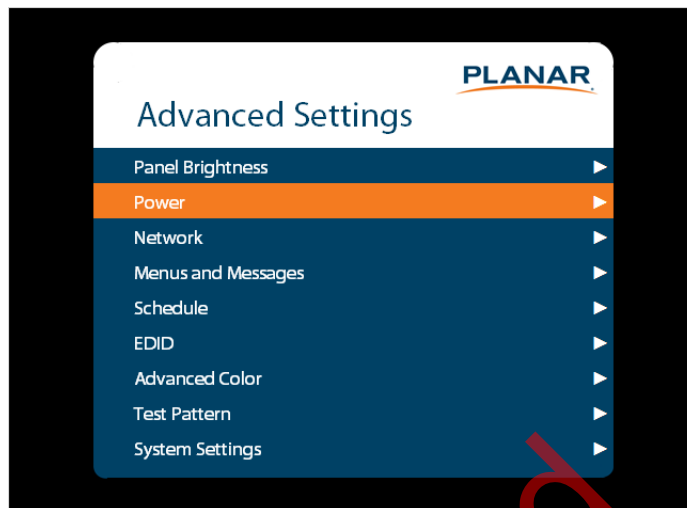

Panel Brightness Submenu



Intensity

Set the intensity of the LCD backlight
Range: 0~100; **Default:** 75

Local Dimming

Turn on or off the local dimming function, if supported by the display
Options: On, Off; **Default:** On

Power Submenu

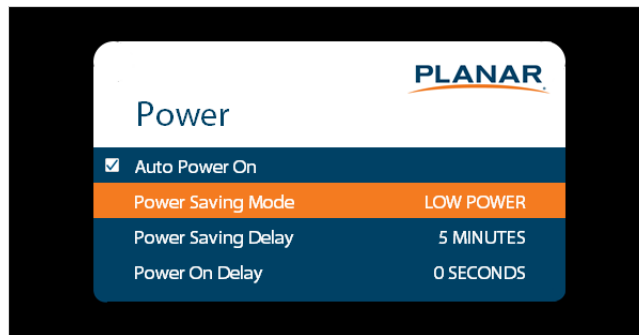
**Auto Power On**

Set whether the system will automatically leave standby mode after AC power is applied
Options: On, Off; **Default:** Off

Power Saving Mode

Set the action to take if there is no signal detected after the period of time selected by the Power Saving Delay setting:

- **Disabled:** The display will remain on even if no signal is present.
- **Low Power:** The display will enter standby mode if no signal is detected after the specified period of time.
- **Wake on Signal:** The display will enter a reduced power mode if no signal is detected after the specified period of time. When in this state, the display will turn on when a signal is detected or when any key is pressed on the keypad or IR remote.

Default: Low Power

Power Saving Delay

Set the number of minutes to delay before initiating the power saving mode action (if any)

Options: 1 Minute, 5 Minutes, 15 Minutes, 30 Minutes, 60 Minutes; **Default:** 5 minutes

Power On Delay

Select the amount of time to delay before turning on the display. Depending on the electrical capabilities at the installation site, it can be necessary to adjust the power on sequence of the displays if there are multiple displays in the installation. Use this control to ensure that each display will power on at a different time, avoiding such problems.

Options: 0-10 seconds, in 0.1 second increments; **Default:** 0 seconds

Network Submenu

The default static IP values are:

- IP Address: 192.168.12.12
- Subnet Mask: 255.255.255.0
- Default Gateway: 192.168.12.1

The static IP settings that you program will be used if a DHCP server cannot be found.

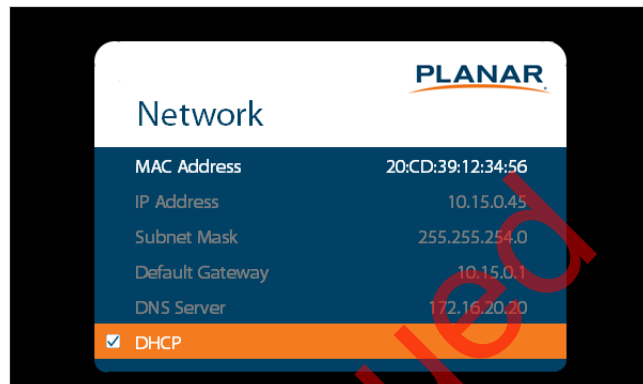

MAC Address

The MAC address of the system

IP Address

The current network address. You can use the number keys on the remote to enter this information.

Subnet Mask

The current subnet mask. You can use the number keys on the remote to enter this information.

Default Gateway

The current default gateway. You can use the number keys on the remote to enter this information.

DNS Server

The current DNS server. You can use the number keys on the remote to enter this information.

Note: The specified DNS server is used when Use Network Time is checked for the Set Date and Time setting.

DHCP

Turn DHCP on or off

Options: On, Off; **Default:** On

Menus and Messages Submenu

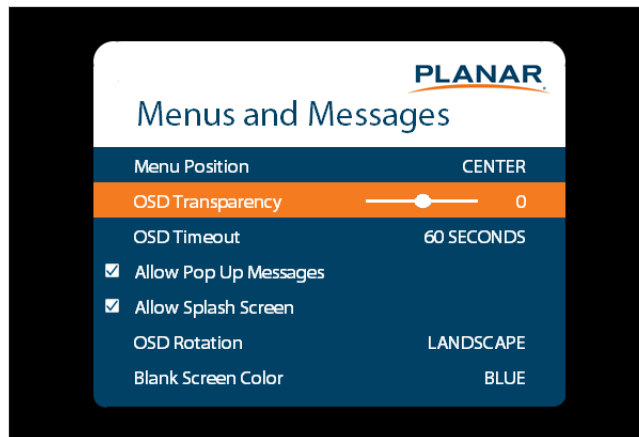
**Menu Position**

Move the OSD menu to a different location on the screen

Options: Center, Upper Left, Upper Right, Lower Left, Lower Right; **Default:** Center

OSD Transparency

Set the transparency of the OSD so that the image behind it can be seen. Higher values mean greater transparency.

Range: 0~5; **Default:** 0

OSD Timeout

Set the amount of time in seconds since the last keypress before the OSD menu automatically closes. If set to Off, the menu never automatically closes.

Options: Off, 10 Seconds, 30 Seconds, 60 Seconds, 120 Seconds, 240 Seconds; **Default:** 60 Seconds

Allow Pop Up Messages

Suppress messages that pop up automatically. When set to No, the source status message and the volume slider bar will not be displayed.

Options: Yes or No; **Default:** Yes

Allow Splash Screen

Enable or disable the splash screen during startup

Options: Enable or Disable; **Default:** Enable

OSD Rotation

Rotate the OSD menu so that it is readable if the display is mounted in portrait orientation

Options: Landscape or Portrait; **Default:** Landscape

Blank Screen Color

Select the color to display when there is no signal in a zone

Options: Black, White, Gray, Red, Green, Blue, Cyan, Magenta, Yellow

Default: Black

Schedule Submenu

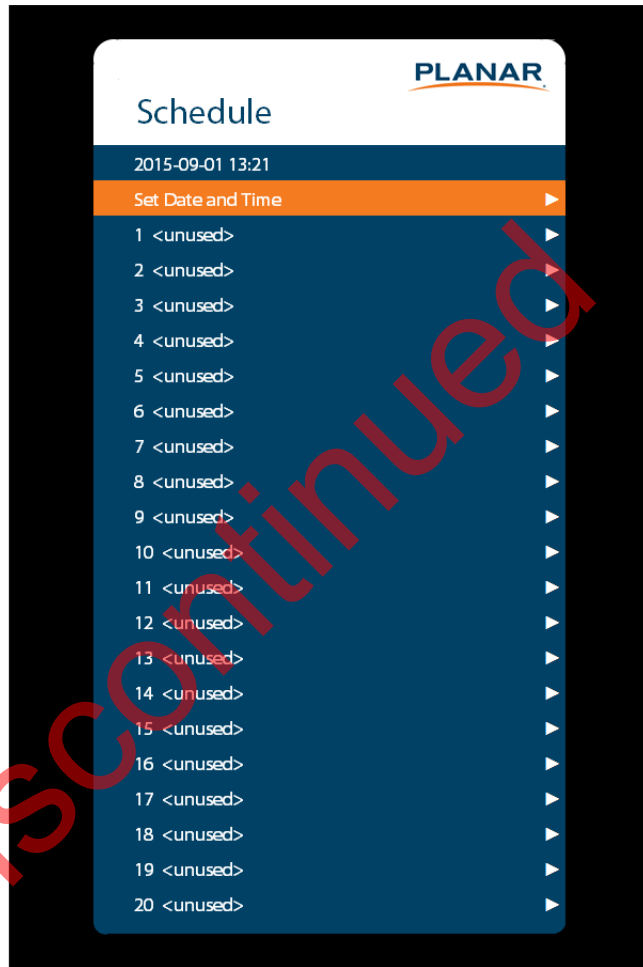

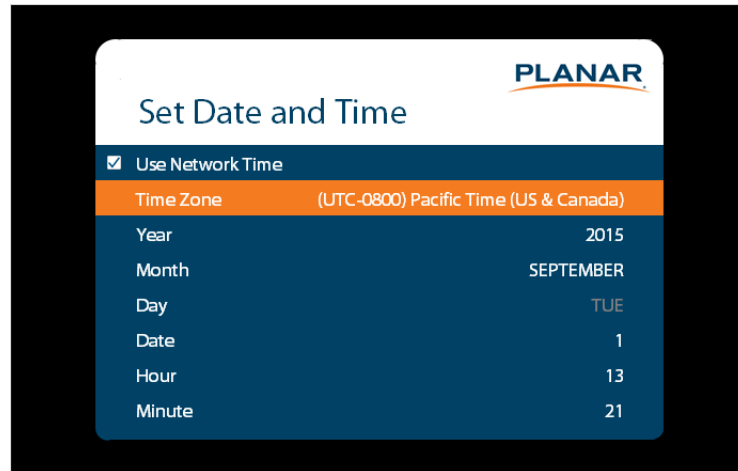

Set Date and Time

Set the internal system clock. If **Use Network Time** is unchecked, you can set the following settings individually: Time Zone, Year, Month, Day, Date, Hour, and Minute.

Note: If Use Network Time is checked and DHCP is unchecked, the display will be unable to obtain the network time unless a DNS server is programmed. This is done via the DNS Server setting in the Network menu or the serial command interface.

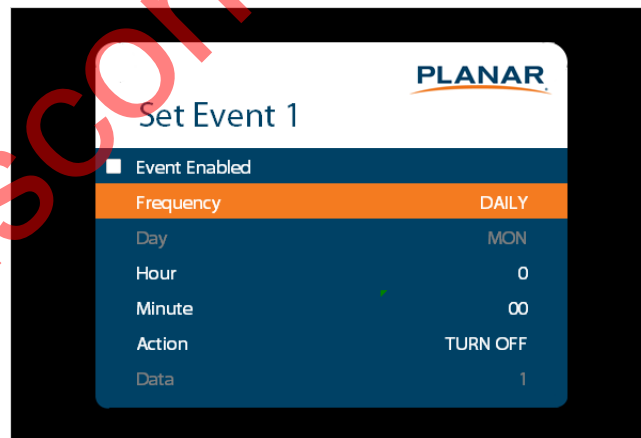

Set Event 1~Event 20

Event Enabled: Turns on the event. If disabled, the settings are saved so that the event can be re-enabled.

Frequency: The frequency of the event. Options are Daily, Weekly, Weekdays, Weekends.

Action: The action to take for the event. Options are Turn On, Turn Off, Panel Brightness.

Data: The backlight setting when the Action is set to Panel Brightness.

EDID Submenu

This menu specifies the EDID format and preferred timing for the selected connector.

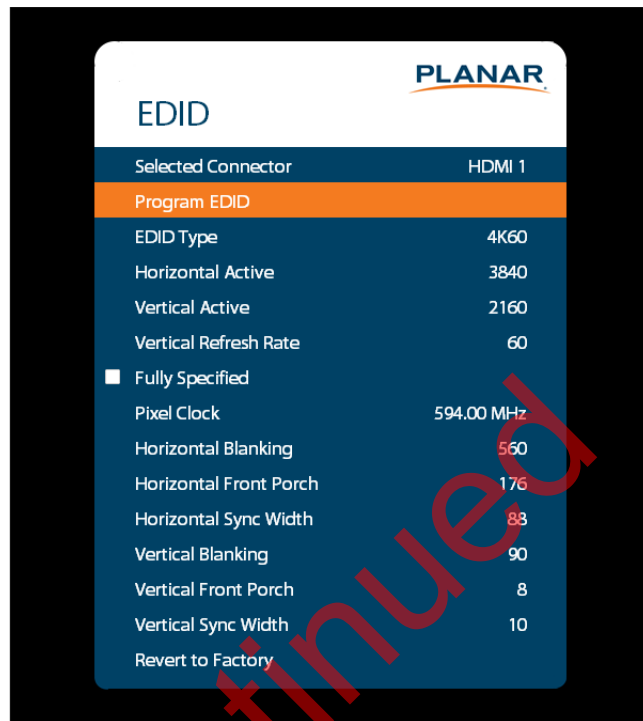

Selected Connector

Set which connector is used

Options: HDMI 1, HDMI 2, HDMI 3, HDMI 4, DP, All

Program EDID

Program the EDID information for the selected connector based on the selections in the EDID submenu

EDID Type

Set the EDID type to determine the base EDID used for the current connector:

- 4K60 selects an EDID format compliant with HDMI 2.0 and DP 1.2
- 4K30 selects an EDID format compliant with HDMI 1.4b and DP 1.1
- 1080P selects an EDID format compliant with HDMI 1.3 and DP 1.1

Options: 4K60, 4K30, 1080P

Horizontal Active

The number of active pixels in a line

Range: 0~4095

Vertical Active

The number of active lines in a field
Range: 0~4095

Vertical Refresh Rate

The number of fields per second rounded to the nearest Hz
Range: 0~120

Fully Specified

Determine how the final detailed timing is calculated. If disabled, it is calculated based on Horizontal Active, Vertical Active, and Vertical Refresh Rate values. If enabled, it is calculated based on all of the EDID values except for Vertical Refresh Rate.

Options: Disabled, Enabled

Note: This setting should only be enabled by advanced users.

Pixel Clock

The value of the pixel clock, in megahertz
Range: 0~600.00, in 0.01 increments

Horizontal Blanking

The number of non-active pixel clocks in a line
Range: 0~1023

Horizontal Front Porch

The number of pixel clocks in the horizontal front porch
Range: 0~1023

Horizontal Sync Width

The number of pixel clocks in the horizontal sync pulse
Range: 0~255

Vertical Blanking

The number of non-active lines in a field
Range: 0~255

Vertical Front Porch

The number of line times in the vertical front porch
Range: 0~255

Vertical Sync Width

The number of line times in the vertical sync
Range: 0~255

Revert to Factory

Reset the EDID type and timings to the default values for the selected connector

Advanced Color Submenu

This menu adjusts the color coordinates of the current zone. These controls are used by advanced installers to achieve exact color point targets on the display. In some cases, the target color coordinates may not be achievable. In this case, an asterisk (*) will appear next to the color coordinate value.

Note: The white color point should be adjusted before adjusting the other color points.

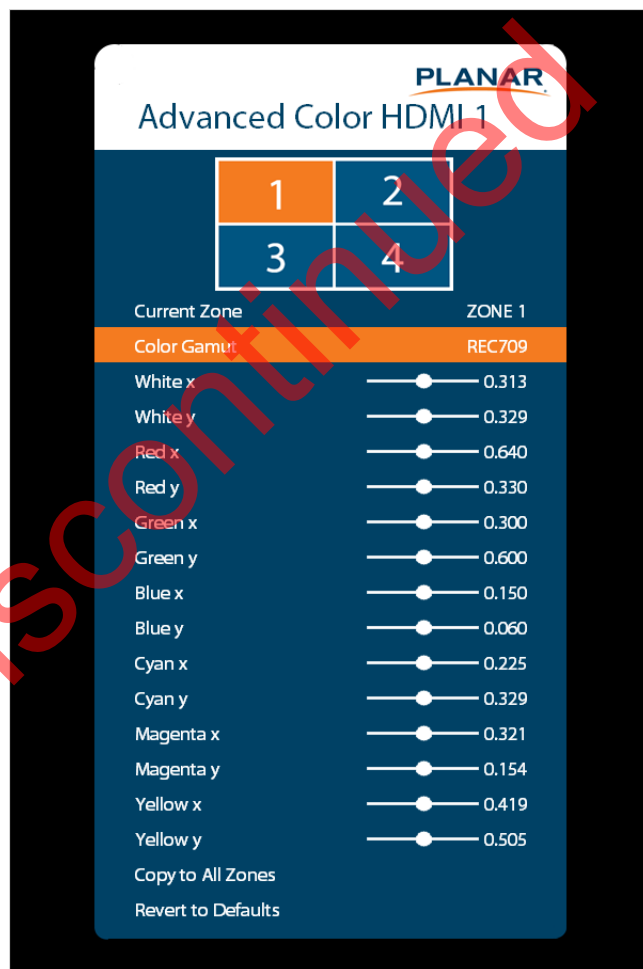

Current Zone

The zone that is currently being adjusted. All of the settings in this menu are saved per zone, and all color coordinate values are also saved per Color Gamut setting. The zone's corresponding input source is shown in the title bar, and the graphic beneath that shows which zone is being adjusted in the current Multi-Source View mode and Advanced Layout setting (if applicable).

The current zone can be changed via the menu or by using the ZONE 1-4 keys on the remote control.

Note: Changing the Current Zone setting via the ZONE 1-4 keys also changes the Audio Select setting.

White x

Adjust the x coordinate of the white color point
Range: 0.000-0.800

White y

Adjust the y coordinate of the white color point
Range: 0.000-0.800

Red x

Adjust the x coordinate of the red color point
Range: 0.000-0.800

Red y

Adjust the y coordinate of the red color point
Range: 0.000-0.800

Green x

Adjust the x coordinate of the green color point
Range: 0.000-0.800

Green y

Adjust the y coordinate of the green color point
Range: 0.000-0.800

Blue x

Adjust the x coordinate of the blue color point
Range: 0.000-0.800

Blue y

Adjust the y coordinate of the blue color point
Range: 0.000-0.800

Cyan x

Adjust the x coordinate of the cyan color point
Range: 0.000-0.800

Cyan y

Adjust the y coordinate of the cyan color point
Range: 0.000-0.800

Magenta x

Adjust the x coordinate of the magenta color point
Range: 0.000-0.800

Magenta y

Adjust the y coordinate of the magenta color point
Range: 0.000-0.800

Yellow x

Adjust the x coordinate of the yellow color point
Range: 0.000-0.800

Yellow y

Adjust the y coordinate of the yellow color point
Range: 0.000-0.800

Copy to All Zones

Copy the color coordinate settings for the current zone and the current Color Gamut setting to all other zones

Revert to Defaults

Reset the color coordinate settings for the current zone and the current Color Gamut setting to their default values

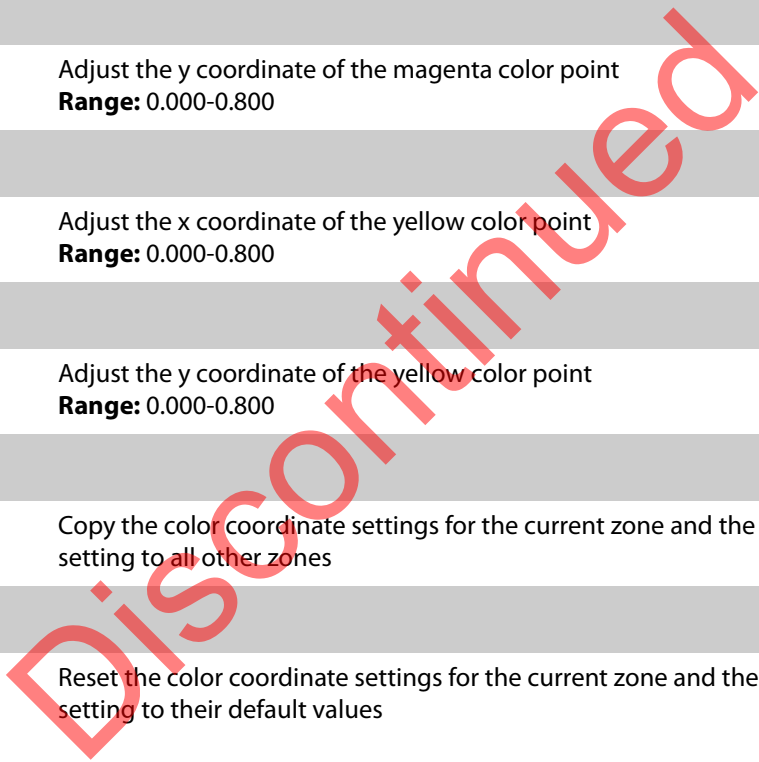

Test Patterns Submenu

This menu selects a test pattern to show on the display for diagnostic purposes.

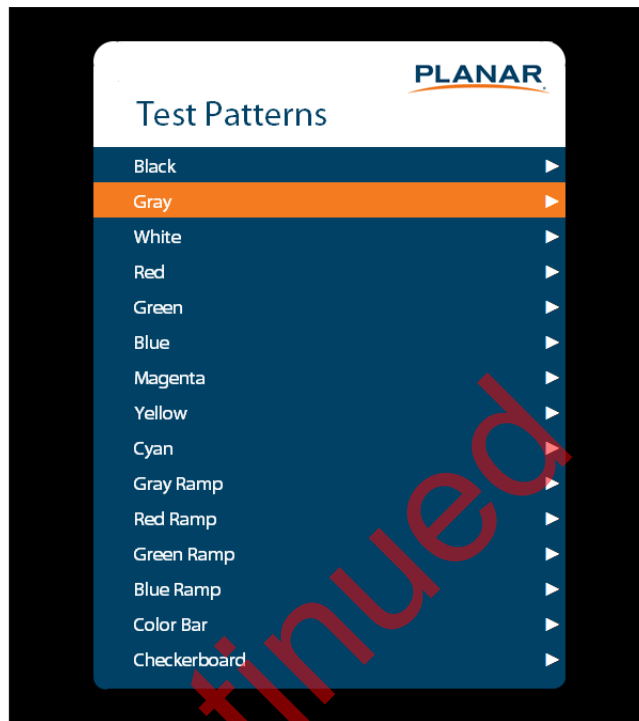

Test Patterns

Options: Black, Gray, White, Red, Green, Blue, Magenta, Yellow, Cyan, Gray Ramp, Red Ramp, Blue Ramp, Color Bar, Checkerboard

System Settings Submenu

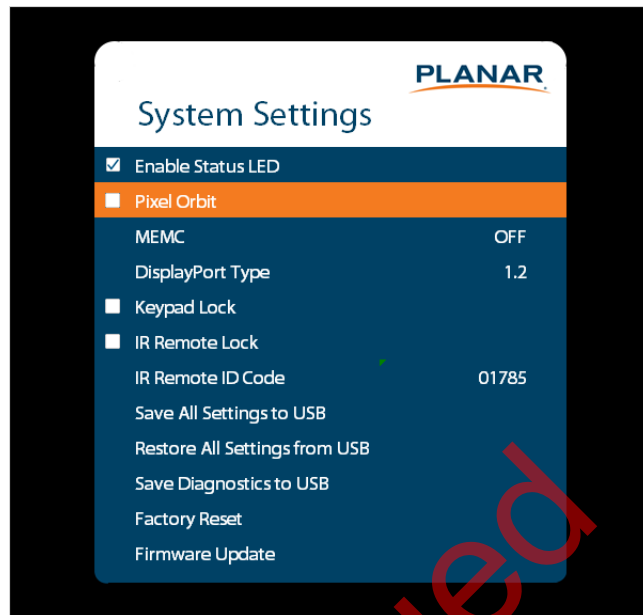
**Enable Status LED**

When enabled, the status LEDs on the back of the display behave as indicated on page 14. When disabled, the status LEDs are always turned off.

Options: Disable, Enable; **Default:** Enable

Pixel Orbit

Create slight frame motion to help avoid image retention

Options: Enable, Disable; **Default:** Disable

MEMC

Enable motion estimation motion compensation (frame interpolation). This improves smoothness for fast motion video content.

Options: Off, Low, Medium, High; **Default:** Off

DisplayPort Type

Set the version of DisplayPort that is used by the system

Options: 1.1, 1.2; **Default:** 1.2

Keypad Lock

Lock or unlock the keypad. When it is enabled, all keypad presses will be ignored.

Options: Enable, Disable; **Default:** Disable

IR Remote Lock

Lock or unlock the remote control. When it is enabled, all remote control presses will be ignored.

Options: Enable, Disable; **Default:** Disable

IR Remote ID Code

Selects the IR remote code set accepted by the display

Options: 00000-65535; **Default:** 01785

Save All Settings to USB

Save all settings in the display to a USB flash drive. The saved file will be named *Planar-settings.bin* and will be saved in the root folder of the USB flash drive.

Note: A USB flash drive must be inserted into the USB-A connector prior to using this feature. The USB flash drive must be formatted as FAT32. This feature will not work with the NTFS file system.

Restore All Settings from USB

Restores all settings in the display from a USB flash drive. The settings file must be named *Planar-settings.bin* and must be located in the root folder of the USB flash drive.

Note: A USB flash drive must be inserted into the USB-A connector prior to using this feature. The USB flash drive must be formatted as FAT32. This feature will not work with the NTFS file system.

Save Diagnostics to USB

Save a diagnostic report to a USB flash drive to help Planar Technical Support troubleshoot any issues. The saved file will be named *Planar-diagnostics.bin* and will be saved in the root folder of the USB flash drive.

Note: A USB flash drive must be inserted into the USB-A connector prior to using this feature. The USB flash drive must be formatted as FAT32. This feature will not work with the NTFS file system.

Factory Reset

Return the saved settings in a system to their factory defaults

Firmware Update

Update the firmware for the display. Refer to the instructions on the firmware release package for more information.

Information Menu

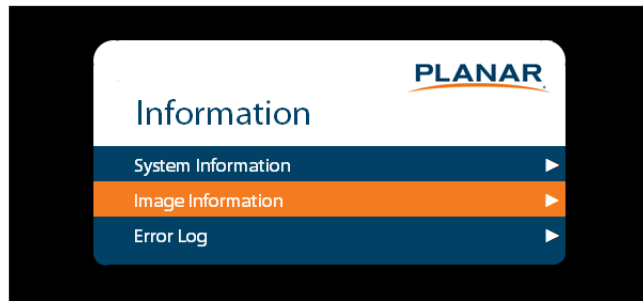

System Information Submenu

This menu displays version information for all programmable parts in the system. It also contains the model and serial number.

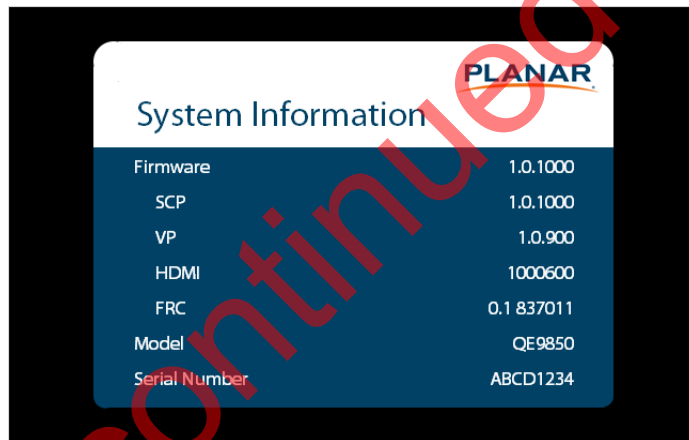

Image Information Submenu

This menu displays image details for the current zone. If more than one zone is available, you can change zones by setting the **Current Zone** option.



Discontinued

Error Log Submenu

This menu displays a chronological list of system errors that have occurred. For a list of possible errors, see "Error Codes" on page 66.

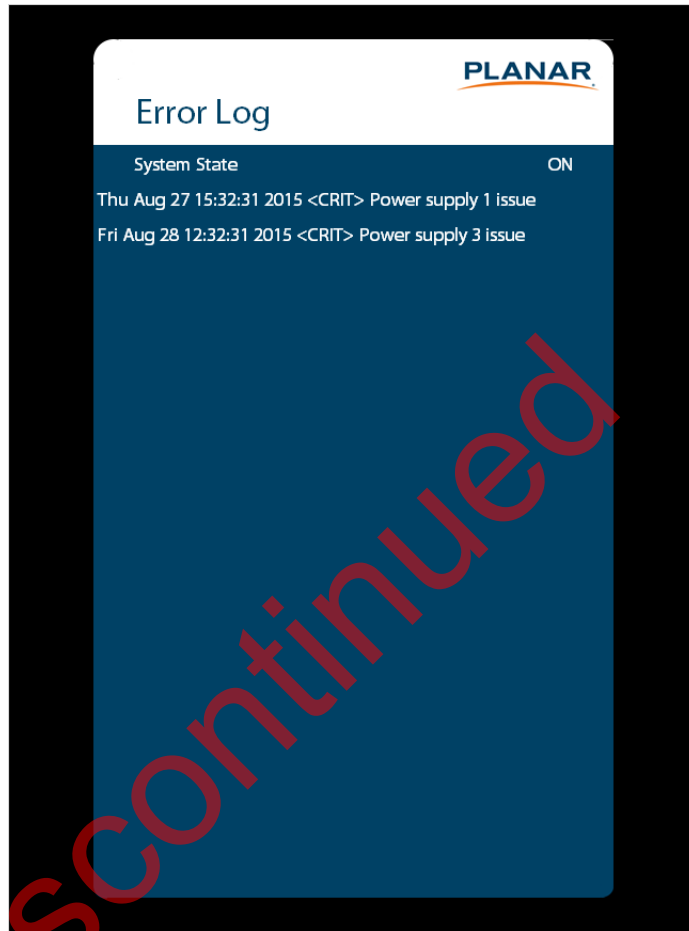

Using the Touch Screen

You can use the touch screen to control your Windows, Mac or Linux operating system. The Planar QE Series is HID compliant, delivering up to 20 points of touch on both Windows and Linux without a driver. Single touch only is supported for Mac operating systems. To achieve more than single touch Mac support, drivers will need to be installed, which can be found on <http://www.planar.com/support>.

Note: Ensure that you have installed the USB cable on the display to a computer.

Discontinued

Planar QE Series Remote Monitoring Software

Planar QE Series Remote Monitoring is a software tool that displays information about the display via a web browser. It is used primarily to access the settings in the OSD as well as provides some additional features.

Remote Monitoring Home

Launch a web browser. Enter the IP address shown in the Network menu (see page 30). If successful, you should see the Remote Monitoring System Information page.

Remote Monitoring System Information

This page displays version information for all programmable parts in the system. It also contains the model and serial number.

For the OSD equivalent, refer to "System Settings Submenu" on page 40.

The screenshot displays the Planar QE Series Remote Monitoring System Information page. The page is titled "Planar QE Series" and "System Information". The left sidebar contains a navigation menu with items: Admin, System Information, Inputs and Views, Audio, Advanced, Panel Brightness and Power, Notifications, System Settings, and Access Control. The main content area is divided into three sections: Summary, Product Information, and Version Information.

Summary	
System State:	ON
Multi-Source View:	QUAD
Audio Input:	HDMI.1
Volume:	50
Mute:	OFF
Pattern/OSD On Screen:	No
Network IP Address:	10.15.0.96

Product Information	
Model:	QE4050
Serial:	ABCD1234

Version Information	
Firmware:	1.2.987
SCP:	1.2.987
VP:	1.2.992
HDMI:	01000600
FRC:	0.1.837011

Remote Monitoring Inputs and Views

This page shows how the sources will be laid out on the screen based on the current Multi-Source View and Advanced Layouts selections.

For the OSD equivalent, refer to "Inputs and Views Menu" on page 22.

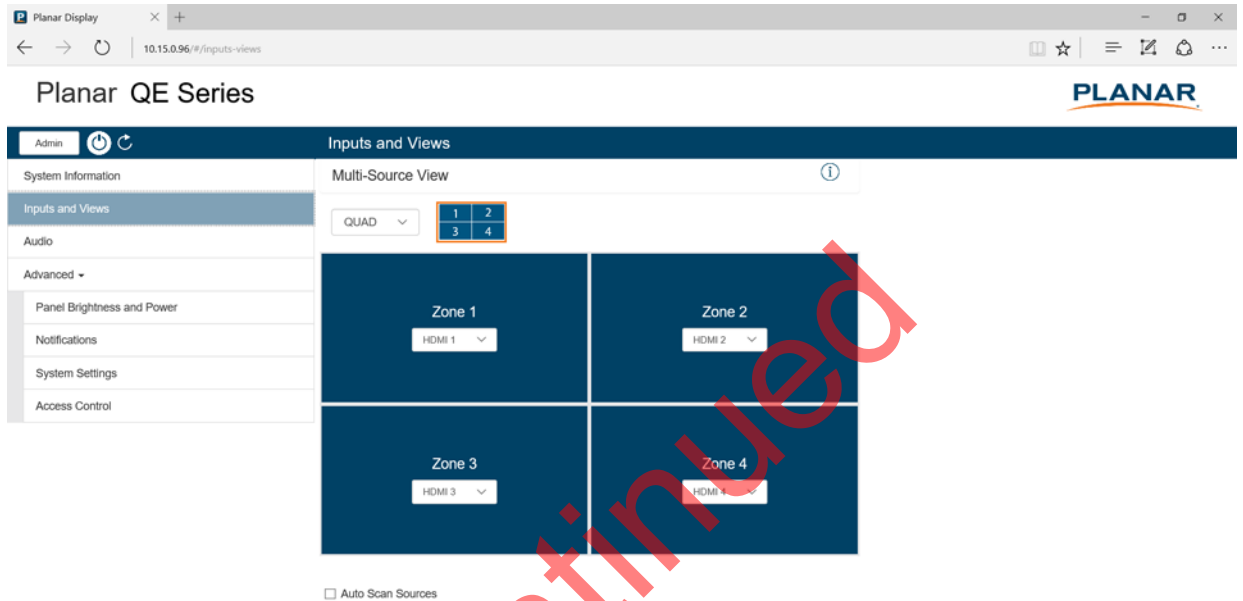

Remote Monitoring Audio

This page enables you to make audio adjustments to the selected zone.

Note: Volume, Bass, Treble and Balance do not apply to the S/PDIF output.

For the OSD equivalent, refer to "Audio Menu" on page 26.

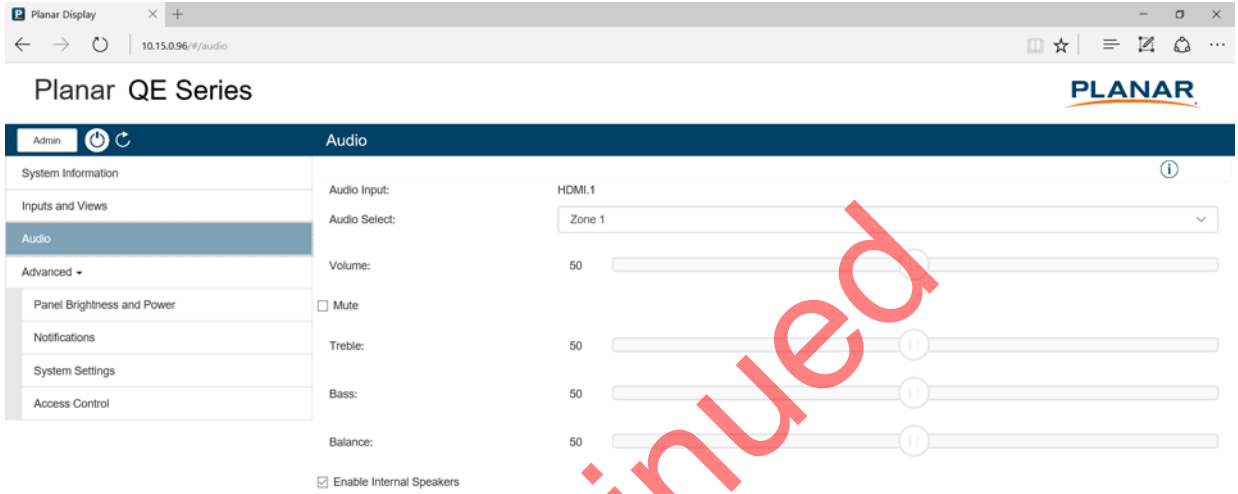

Remote Monitoring Panel Brightness and Power

This page enables you to make adjustments to the brightness and power settings.

For the OSD equivalents, refer to "Panel Brightness Submenu" on page 28 and "Power Submenu" on page 29.

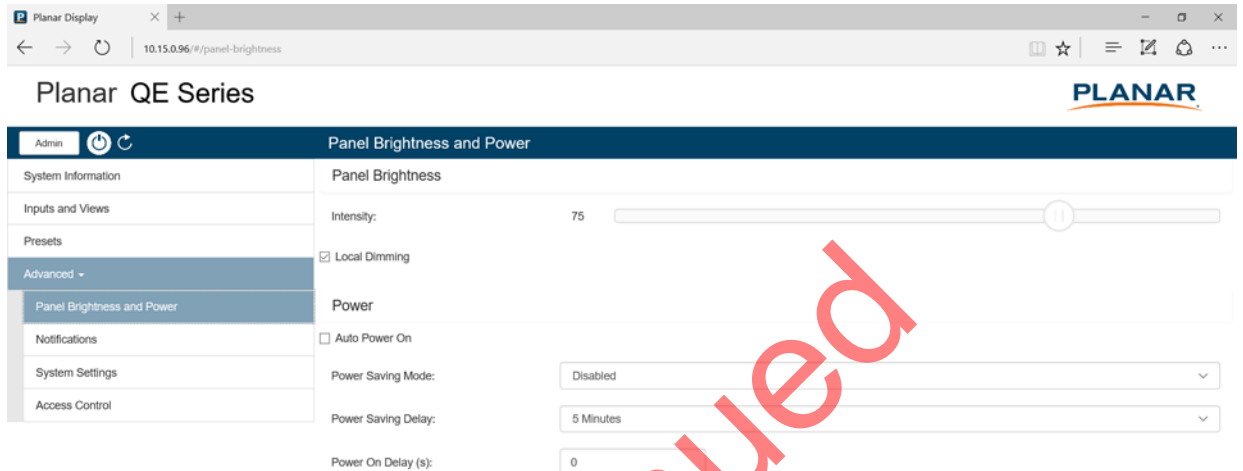

Remote Monitoring Notifications

This page enables you to send email notifications on certain events.

The screenshot shows the 'Planar QE Series' web interface. The 'Notifications' section is active, displaying 'Email Account Settings' and 'Notification Events'. The 'Email Account Settings' fields are as follows:

- SMTP Server: smtp.comcast.net
- Connection Encryption: TLS
- Port: 465
- Authentication: Auto
- User Name: mgirardelli
- Password: server login password
- Email From Address: mgirardelli@comcast.net

The 'Notification Events' table is as follows:

Event	Recipient(s)	Additional Note	Enabled
Power On/Off	marques.girardelli@planar.com	Testing 12345678	<input type="checkbox"/>
System Error			<input type="checkbox"/>

Note: Obtain this information from your ISP or network administrator.

The options under **Email Account Settings** are:

- **SMTP Server:** The name of the outgoing SMTP server. Obtain this information from your ISP.
- **Connection Encryption:** Selects the appropriate encryption method required by the SMTP server.
- **Port:** Selects the port that the SMTP server uses.
- **Authentication:** Use Auto unless directed by your ISP or network administrator.
- **User Name:** Login username for the SMTP server.
- **Password:** Login password for the SMTP server.
- **Email From Address:** The email address that will be shown in the "From:" field of the notification emails.

The options under **Notification Events** are:

- **Power On/Off:** Occurs when standby mode is entered and when the display is powered on.
- **System Error:** Occurs when the display has detected an error within the system.
- **Source Detect:** Occurs when the display detects and displays a new input signal.
- **Source Lost:** Occurs when the current input signal is no longer detected.
- **Source Selected:** Occurs when a different input source is selected for any of the zones.

Note: Each event can be sent to one or more recipients. To add multiple email addresses, separate them by a space.

- **Test Email:** Sends a test of the selected email notification. This is useful for verifying that your email account settings are setup correctly. If the test email fails, you can use the **View Last 10 Log Messages** button to get more detailed information about the failure.

Remote Monitoring System Settings

This page enables you to make adjustments to a variety of system settings.

For the OSD equivalent, refer to "System Settings Submenu" on page 40.

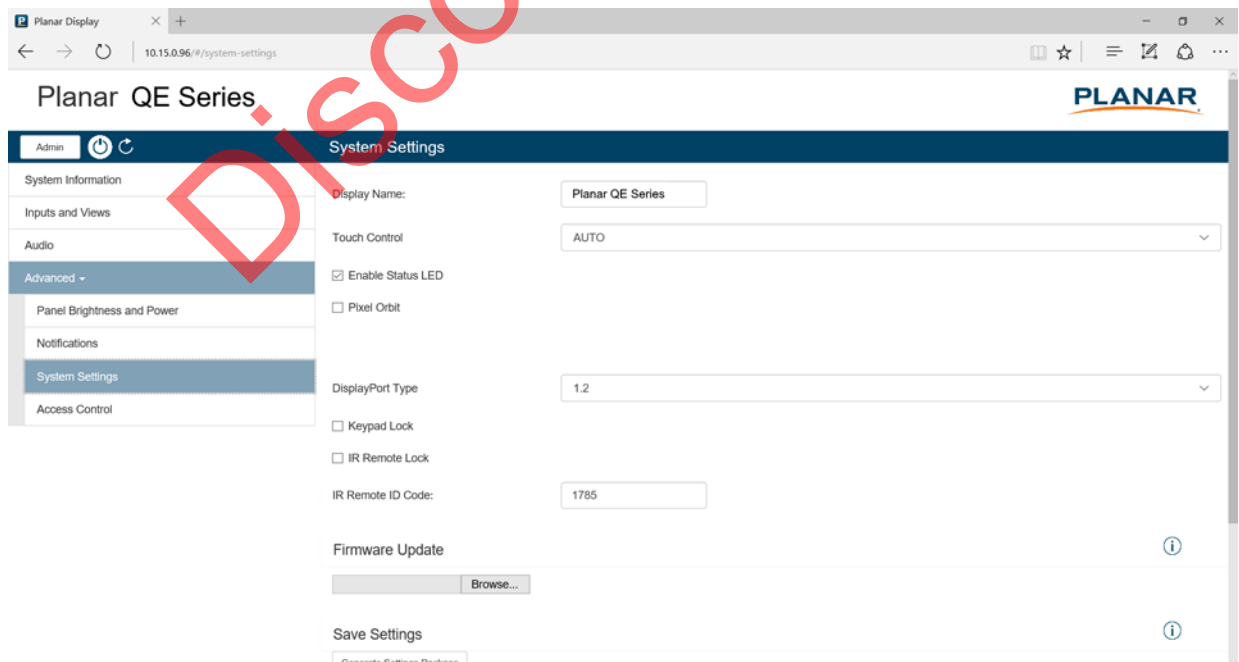

Remote Monitoring Access Control

This page enables you to limit the ability to access certain features in the web server by password protecting them.

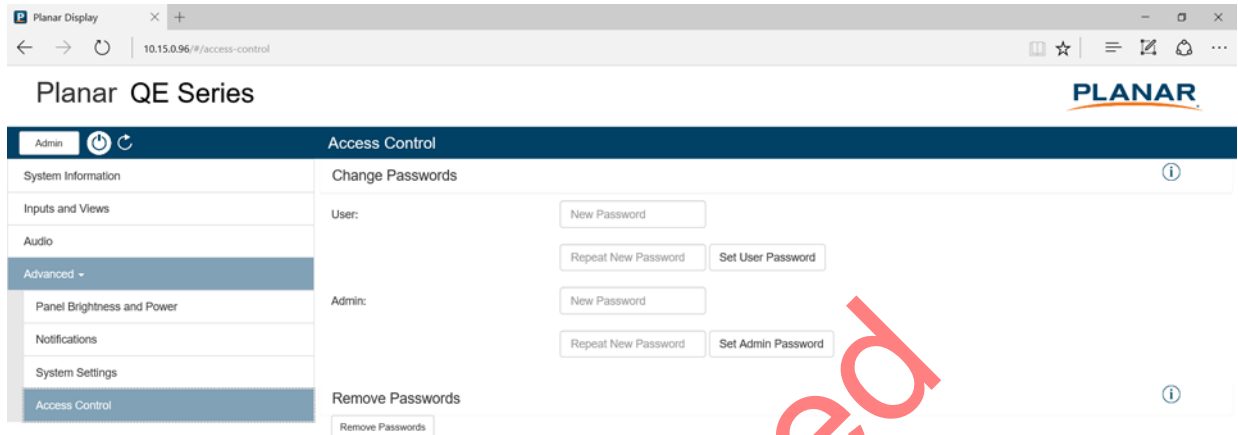

All functions other than the following require Admin level access:

- Power On/Off
- System Information
- Inputs and Views
 - Multi-Source View
 - Zone inputs
- Audio
 - Volume
 - Mute
- Panel Brightness and Power
 - Panel Brightness

With the exception of System Information, all functions listed above require User level access.

If no password is set for either access level, all functions can be accessed. By default, there are no passwords for either access level.

External Control

In addition to using the Planar QE Series remote control and display, there are other methods of controlling the Planar QE Series display externally:

- Using a serial link to send ASCII commands and to receive responses to those commands. The same set of commands can be sent over RS-232, USB, TCP or UDP. See the *Planar QE Series RS232 User Manual* for more information.
- Using discrete infrared (IR) codes to program a third-party remote control. See "IR Command Protocol" on page 16.
- Using the Planar QE Series Remote Monitoring software to access the settings in the OSD as well as some additional features via a web browser. See "Planar QE Series Remote Monitoring Software" on page 46.

Discontinued

Signal Compatibility

Signal Type	Resolution	Frame rate (Hz)	Line Rate (kHz)	Pixel Rate (MHz)	HDMI 1-2	HDMI 3-4	DisplayPort	References
PC	640x480	59.94	31.469	25.175	x	x	x	VESA DMT, CEA-861-F Format 1
	640x480	72	37.861	31.500	x	x	x	VESA DMT
	640x480	74.99	37.500	31.500	x	x	x	VESA DMT
	640x480	85	43.269	36.000	x	x	x	VESA DMT
	800x600	60.32	37.890	40.000	x	x	x	VESA DMT
	800x600	72	48.077	50.000	x	x	x	VESA DMT
	800x600	75	46.875	49.500	x	x	x	VESA DMT
	800x600	85.06	53.674	56.250	x	x	x	VESA DMT
	848x480	59.659	29.830	31.500	x	x	x	VESA CVT
	848x480	74.769	37.684	41.000	x	x	x	VESA CVT
	848x480	84.751	42.969	46.750	x	x	x	VESA CVT
	1024x768	60	48.363	65.000	x	x	x	VESA DMT
	1024x768	70	56.476	75.000	x	x	x	VESA DMT
	1024x768	75.03	60.023	78.750	x	x	x	VESA DMT
	1024x768	85.03	68.677	94.500	x	x	x	VESA DMT
	1152x864	70.012	63.851	94.500	x	x	x	VESA DMT
	1152x864	75	67.500	108.000	x	x	x	VESA DMT
	1152x864	84.999	77.094	121.500	x	x	x	VESA DMT
	1280x768	49.929	39.593	65.250	x	x	x	VESA CVT
	1280x768	59.995	47.396	68.250	x	x	x	VESA CVT-R
	1280x768	60	47.776	79.500	x	x	x	VESA CVT
	1280x768	74.893	60.289	102.250	x	x	x	VESA CVT
	1280x768	84.837	68.633	117.500	x	x	x	VESA CVT
	1280x960	60	60.000	108.000	x	x	x	VESA DMT
	1280x960	75	75.000	126.000	x	x	x	VESA DMT
	1280x960	85.002	85.938	148.500	x	x	x	VESA DMT
	1280x1024	60.02	63.981	108.000	x	x	x	VESA DMT
	1280x1024	75.02	79.976	135.000	x	x	x	VESA DMT
	1280x1024	85.02	91.146	157.500	x	x	x	VESA DMT
	1360x768	60	47.712	85.500	x	x	x	VESA DMT

Signal Type	Resolution	Frame rate (Hz)	Line Rate (kHz)	Pixel Rate (MHz)	HDMI 1-2	HDMI 3-4	DisplayPort	References
PC	1400x1050	49.965	54.113	100.000	x	x	x	VESA CVT
	1400x1050	60	64.7	101.00	x	x	x	VESA CVT-R
	1400x1050	60	65.317	121.750	x	x	x	VESA CVT
	1400x1050	74.867	82.278	156.000	x	x	x	VESA CVT
	1600x1200	60	75.000	162.000	x	x	x	VESA DMT
	1920x1080	49.929	55.621	141.500	x	x	x	VESA CVT
	1920x1080	59.963	67.158	173.000	x	x	x	VESA CVT
	1920x1080	59.950	66.587	138.500	x	x	x	VESA CVT-R
	1920x1200	49.932	61.816	158.250	x	x	x	VESA CVT
	1920x1200	59.950	74.038	154.000	x	x	x	VESA CVT-R
	1680x1050	49.974	54.121	119.500	x	x	x	VESA CVT
	1680x1050	59.954	65.290	146.250	x	x	x	VESA CVT
	1920x2160	60	135.000	297.000	x	x	x	CEA-861-F, VIC 16, with vertical parameters doubled
	2560x1440	59.951	88.787	241.500	x	x	x	VESA CVT-R
	2560x1600	59.972	98.713	268.500	x	x	x	VESA CVT-R
	3840x2160	24	52.438	209.750	x	x	x	VESA CVT-R
	3840x2160	30	65.688	262.750	x	x	x	VESA CVT-R
	3840x2160	50	110.500	442.000	x		x	VESA CVT-R
3840x2160	60	133.313	533.250	x		x	VESA CVT-R	
Apple Mac	640x480	66.59			x	x	x	
	832x624	75.087	49.107	55.000	x	x	x	
	1024x768	59.278	48.193	64.000	x	x	x	
	1024x768	74.927	60.241	80.000	x	x	x	
	1152x870	75.062	68.681	100.000	x	x	x	
SDTV	480i	60			x	x	x	SMPTE 125M, CEA-861-F Formats 6 & 7
	576i	50			x	x	x	ITU-R BT.601, CEA-861-F Formats 21 & 22
EDTV	480p	60	31.469	27.000	x	x	x	ITU-R BT.1358, CEA-861-F Format 17 & 18
	576p	50	31.250	27.000	x	x	x	SMPTE 125M, CEA-861-F Format 6 & 7

Signal Type	Resolution	Frame rate (Hz)	Line Rate (kHz)	Pixel Rate (MHz)	HDMI 1-2	HDMI 3-4	DisplayPort	References
HDTV	1080i	50	28.125	74.500	x	x	x	SMPTE 274M, CEA-861-F Format 20
	1080i	60	33.750	74.250	x	x	x	SMPTE 274M, CEA-861-F Format 5
	720p	50	37.500	74.250	x	x	x	SMPTE 296M, CEA-861-F Format 19
	720p	60	45.000	74.250	x	x	x	SMPTE 296M, CEA-861-F Format 4
	1080p	24	27.000	74.250	x	x	x	SMPTE 274M, CEA-861-F Format 32
	1080p	25	28.125	74.250	x	x	x	SMPTE 274M, CEA-861-F Format 33
	1080p	30	33.750	74.250	x	x	x	SMPTE 274M, CEA-861-F Format 34
	1080p	50	56.250	148.500	x	x	x	SMPTE 274M, CEA-861-F Format 31
	1080p	60	67.500	148.500	x	x	x	SMPTE 274M, CEA-861-F Format 16
UHDTV	3840x2160	24	54.000	297.000	x	x	x	CEA-861-F Format 93, HDMI 1.4b VIC 1
	3840x2160	25	56.250	297.000	x	x	x	CEA-861-F Format 94, HDMI 1.4b VIC 2
	3840x2160	30	67.500	297.000	x	x	x	CEA-861-F Format 95, HDMI 1.4b VIC 3
	3840x2160	50	67.500	297.000	x			CEA-861-F Format 96, 4:2:0 sub-sampling
	3840x2160	50	135.000	594.000	x		x	CEA-861-F Format 96
	3840x2160	60	67.500	297.000	x			CEA-861-F Format 97, 4:2:0 sub-sampling
	3840x2160	60	135.000	594.000	x		x	CEA-861-F Format 97

Color Subsampling Support

Video Timing	Input	RGB 4:4:4 Supported	YUV 4:4:4 Supported	YUV 4:2:2 Supported	YUV 4:2:0 Supported
4K @ 50/60 Hz	DP	x	x	x	
4K @ 50/60 Hz	HDMI 1-2	x	x	x	x
4K @ 50/60 Hz	HDMI 3-4				
All Other Supported Timings	Any	x	x	x	

Discontinued

Specifications

Item	QE7550 QE7550T	QE8650 QE8650T	QE9850 QE9850T
LCD Panel			
Resolution	3840 x 2160		
Aspect Ratio	16:9		
Screen Size	75"	86"	98"
Orientation	Landscape/Portrait		
Brightness (Typ.)	500 cd/m ²	500 cd/m ²	400 cd/m ²
Contrast Ratio (local dimming enabled)	20,000:1		
Contrast Ratio (local dimming disabled)	1200:1	1200:1	1300:1
Viewing Angle (Typ.)	178°		
Response Time (Typ.)	6ms	8ms	8ms
Color Gamut	72% NTSC		
Display Color	1.07 billion (10-bit depth)		
Connectivity			
Standard Inputs	DisplayPort 1.2, HDMI 2.0 x 2, HDMI 1.4 x 2		
Audio Output	Line out, S/PDIF		
Control and Monitoring	LAN RJ45, RS232 In, IR, Keypad		
Mechanical			
Display Dimensions	Standard: 66.2" x 37.7" x 3.24" (1680.3 mm x 958.7 mm x 82.3 mm) Touch: 67.4" x 39" x 3.64" (1711.4 mm x 990.3 mm x 92.4 mm)	Standard: 75.8" x 43.2" x 3.3" (1926.2 mm x 1097.2 mm x 83.7 mm) Touch: 77" x 44.4" x 3.73" (1957 mm x 1128 mm x 94.7 mm)	Standard: 86.3" x 49.1" x 3.83" (2191.8 mm x 1246.8 mm x 97.3 mm) Touch: 87.4" x 50.2" x 4.37" (2219.8 mm x 1275.4 mm x 110.9 mm)
Bezel Width	Standard: 0.60" (15.3 mm) left/right; 0.61" (15.4 mm) top/bottom Touch: 1.22" (30.9 mm) left/right; 1.23" (31.2 mm) top/bottom	Standard: 0.61" (15.6 mm) left/right; 0.62" (15.7 mm) top/bottom Touch: 1.2" (31.0mm) left/right, top/bottom	Standard: 0.63" (16.0 mm) left/right; 0.62" (15.7 mm) top/bottom Touch: 1.2" (31.0mm) left/right, top/bottom

Item	QE7550 QE7550T	QE8650 QE8650T	QE9850 QE9850T
Display Weight	Standard: 115 lbs (52 kg) Touch: 138 lbs (63 kg)	Standard: 126 lbs (57 kg) Touch: 158 lbs (72 kg)	Standard: 187 lbs (85 kg) Touch: 243 lbs (110 kg)
Mounting	VESA 600 mm x 400 mm		
Fanless	Yes		
Speakers	10W x 2 built-in		
Usage			
Recommended Usage	24x7		
Backlight	E-LED	E-LED	D-LED
Backlight Life	30,000 hours min		
Power Source			
Power Consumption (Typ.)	195W	165W	410W
BTU/hr (Typ.)	195W x 3.42 BTU = 667 BTU/hr	165W x 3.42 BTU = 564 BTU/hr	410W x 3.42 BTU = 1402 BTU/hr
Standby Power Consumption	<1W		
Input Voltage / Frequency	AC 100-240V 50-60 Hz		
Environment			
Storage Temperature	Min -4°F ~ Max 140°F (-20°C ~ 60°C)		
Operating Temperature	Min 32°F ~ Max 95°F (0-35°C) at up to 1500 m Min 32°F ~ Max 86°F (0-30°C) at up to 3000 m		
Humidity	20-85% RH		
Approvals	FCC Class A, cTUVus, CE		

Dimensions

QE7550

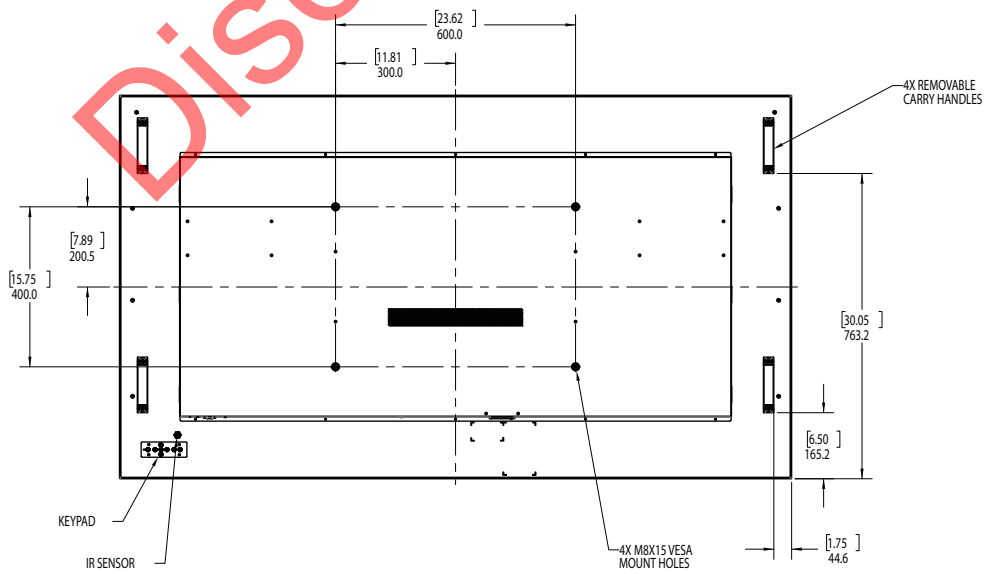
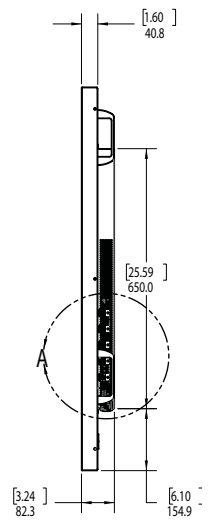
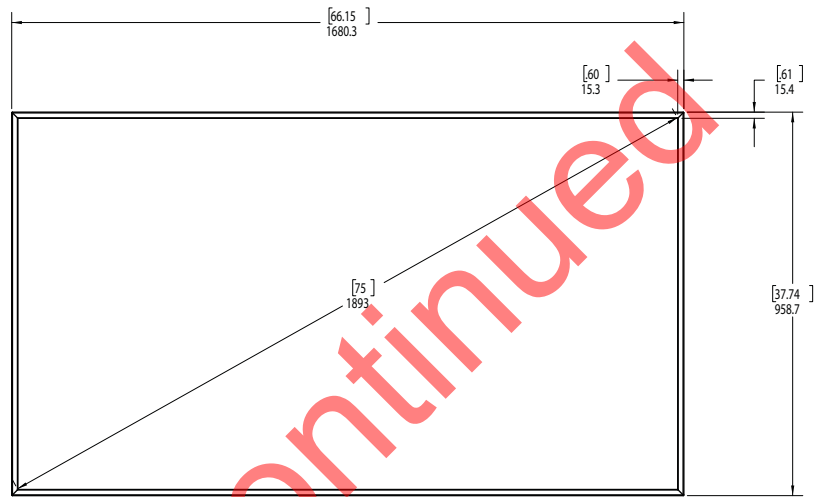
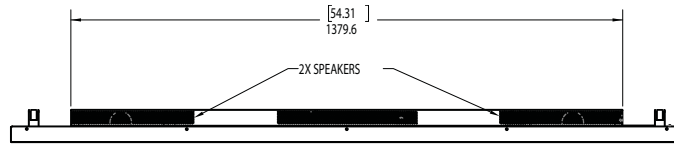

QE7550 Touch

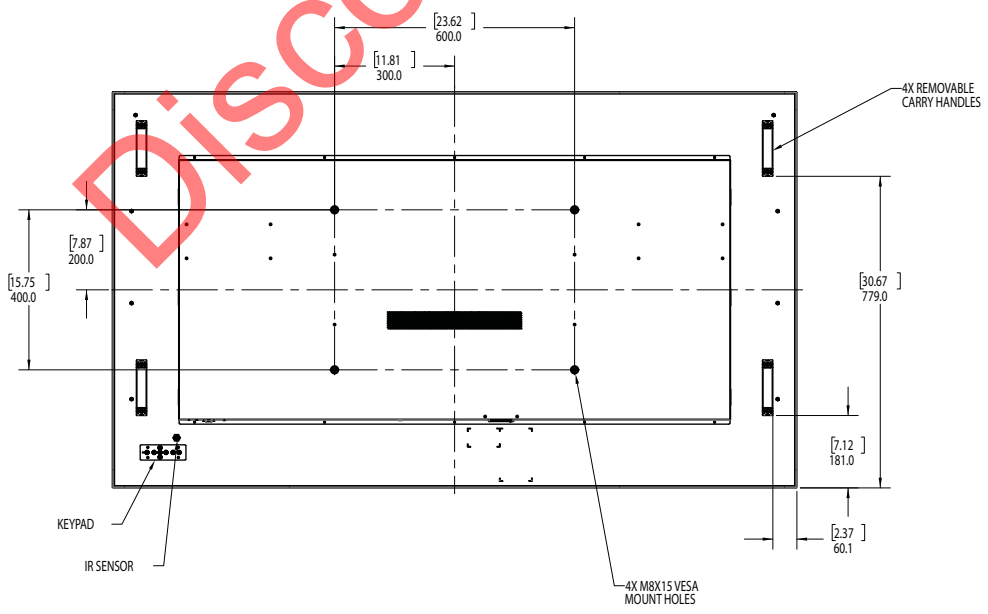
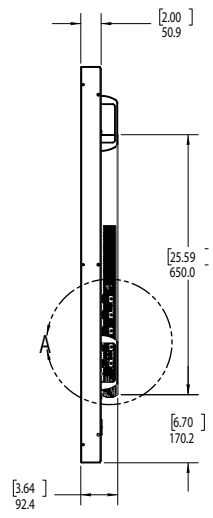
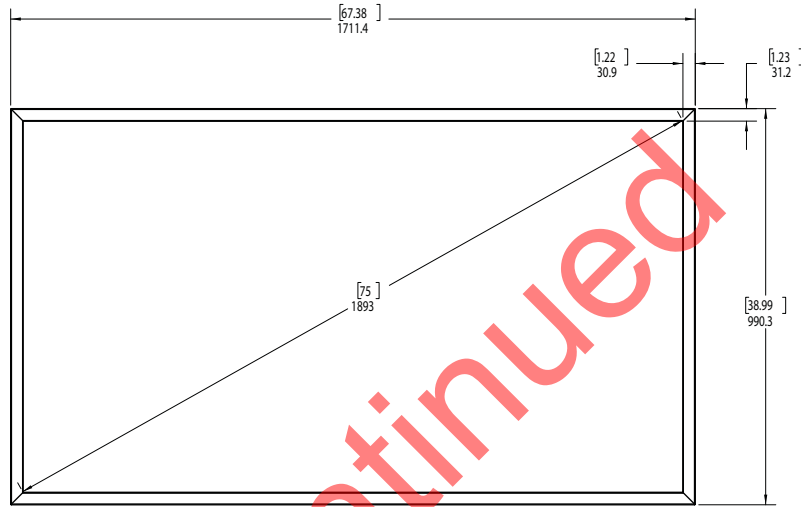
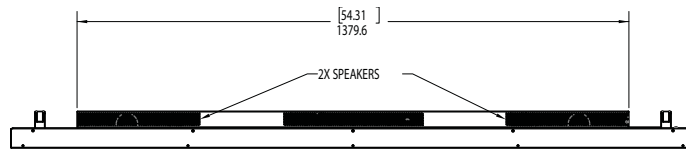

QE8650

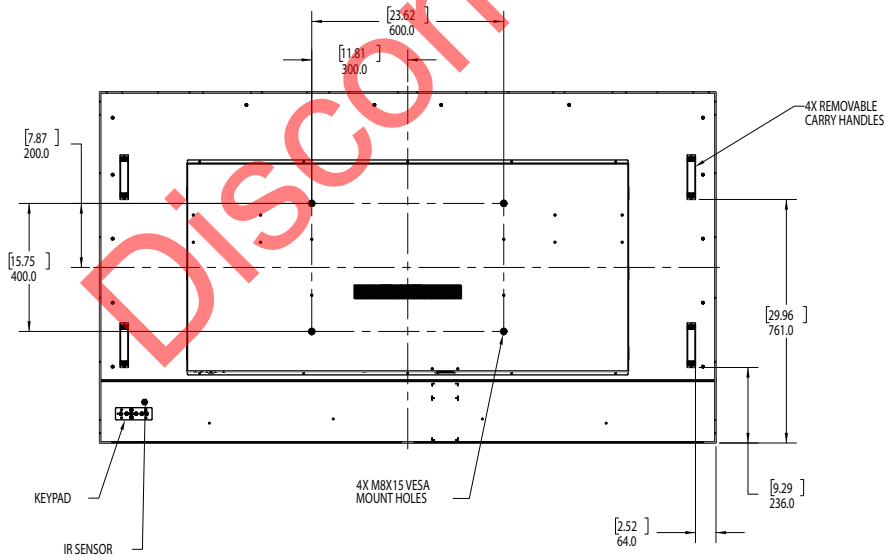
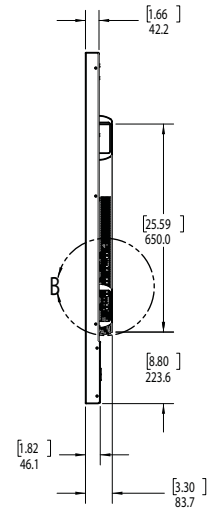
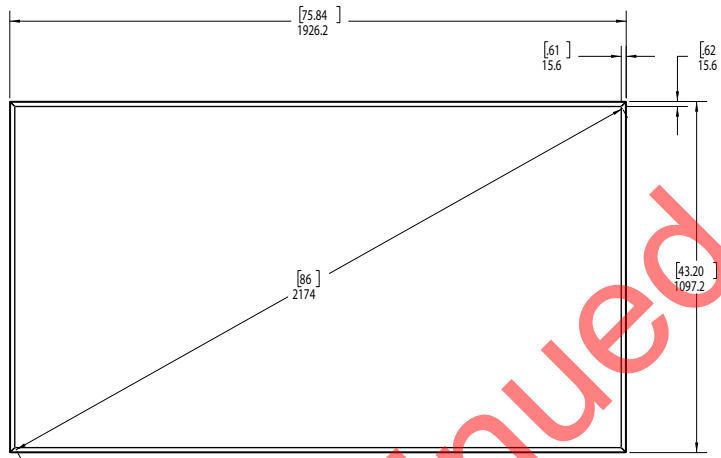
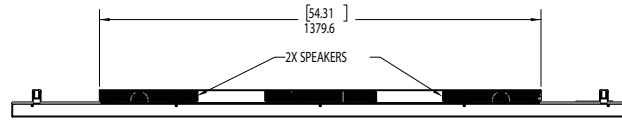

QE9850

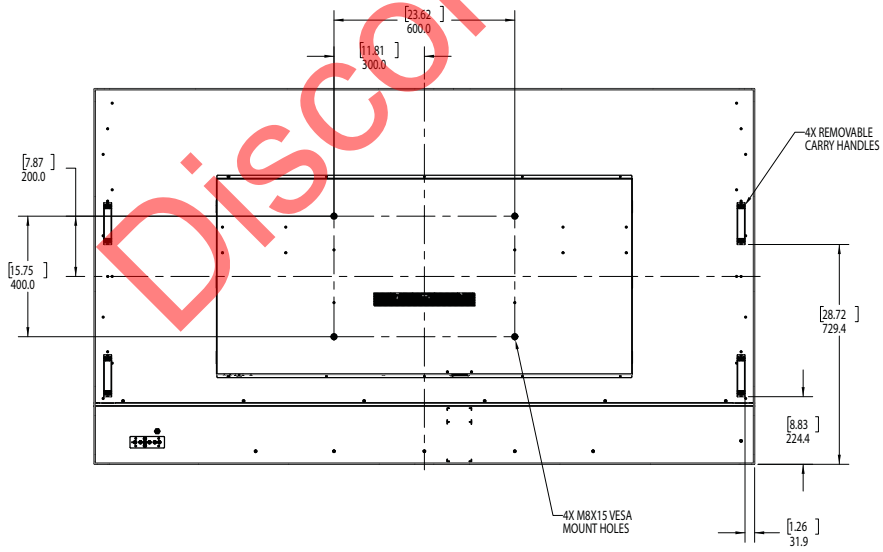
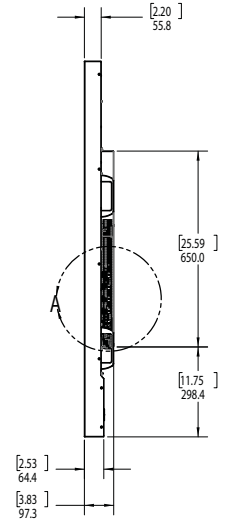
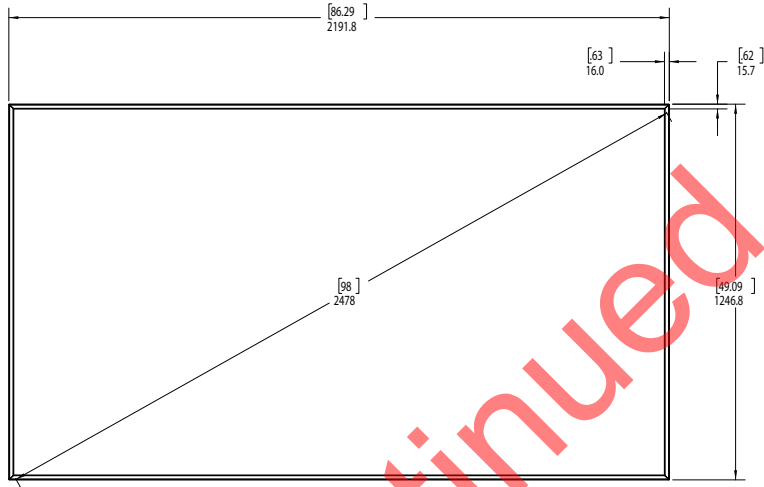
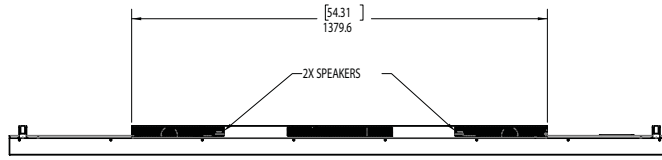

QE9850 Touch

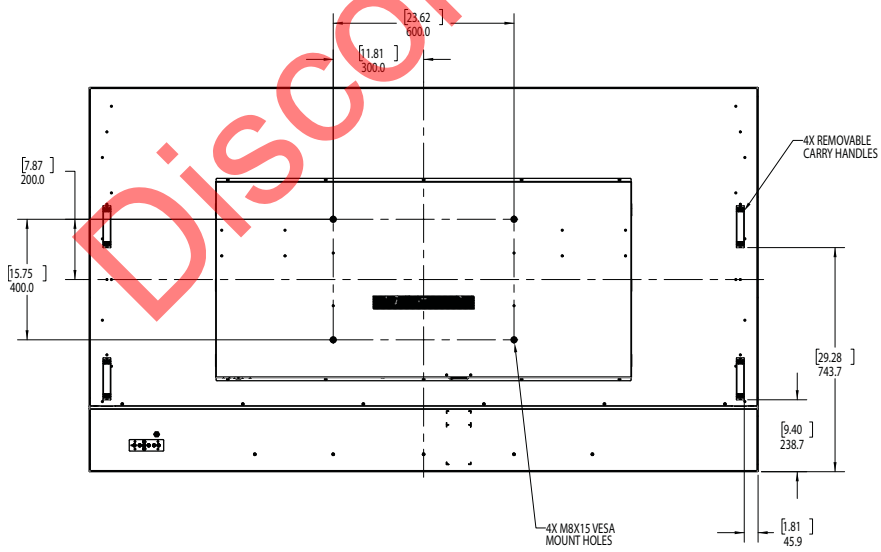
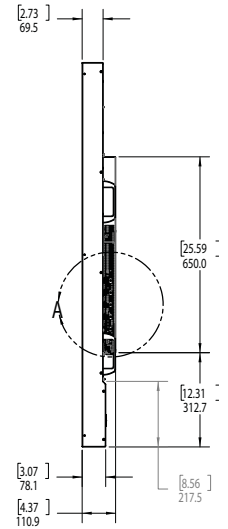
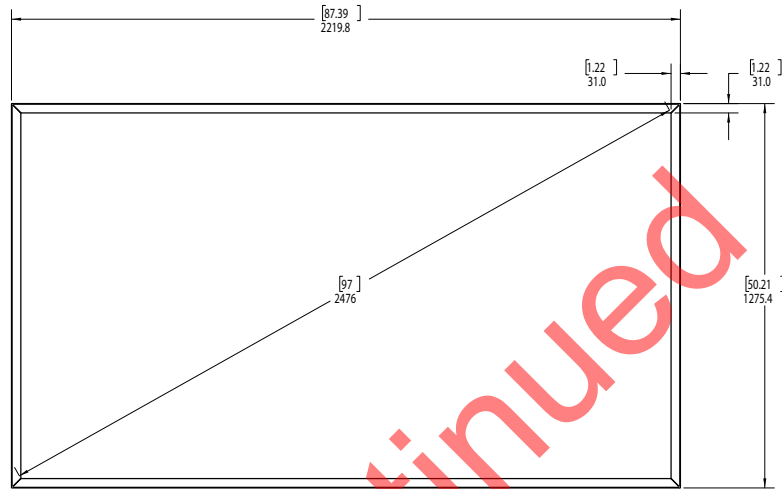
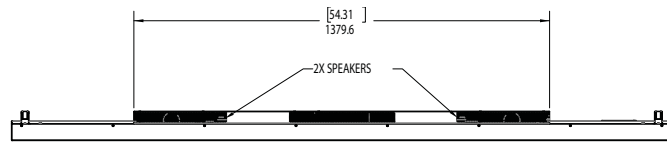

Troubleshooting During Installation

This section includes troubleshooting information about different issues you may encounter during the installation process or after your display has been running for some time. If you are not able to solve your issue in this section, please contact Planar's Technical Support team for assistance.

Error Codes

To see the last 50 errors that have occurred, select the Error Log tab in the OSD (MAIN MENU > INFORMATION > ERROR LOG), as shown below.

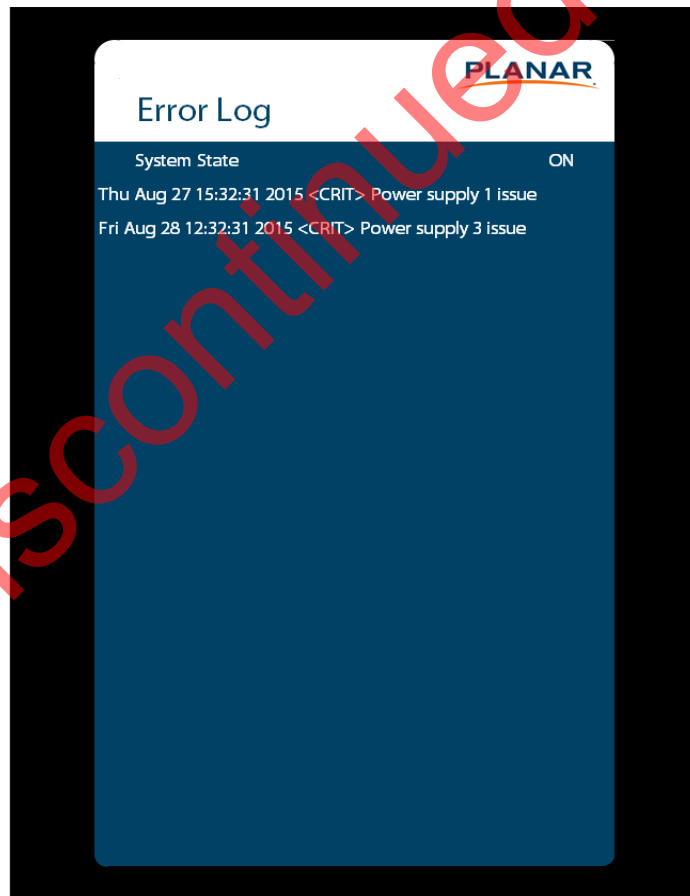

Symptoms, Possible Causes and Solutions

Below are different symptoms that you might encounter as you install your Planar QE Series display. First look at the different symptoms to see if you can find your issue. And then look at the possible cause and try the suggested solution(s). If you still are not able to resolve your issue, please contact Planar's Technical Support Department.

Symptom: Can't Get PC to Output 4K @ 24/30/60 Hz

Solution

Make sure that your graphics card can support a 4K output. See "Supported Graphics Cards" on page 11 for a list of the current graphics cards that Planar supports for the Planar QE Series displays.

Solution

Confirm that you are using a DisplayPort output. You can't use a DisplayPort-to-HDMI adapter to output 4K content.

Solution

Make sure you are using a high-speed HDMI cable. Standard HDMI cables might work but are not guaranteed.

Solution

Verify that the selected **EDID Type** setting in the OSD is **4K60** or **4K30**. If you change the EDID setting, you may need to disconnect and reconnect the cable.

Solution

If you are trying to use 4K @ 60 Hz on HDMI, the display must be connected to HDMI 1 or HDMI 2.

Solution

If you are trying to display 4K @ 60 Hz on HDMI 1 or HDMI 2, the Multi-Source View setting must be Single.

Symptom: Can't Get PC to Output 4K @ 24/30/60 Hz

Possible Cause

The connector overmold is too large, which can cause the pins not to contact properly on some cards.

Solution

If using DisplayPort, make sure the connector overmold isn't too large.



Symptom: IR Isn't Working Properly

Possible Cause

The wired IR module may not be fully connected.

Solution

Make sure the IR is fully connected by pressing hard to ensure it is inserted as far as possible.

Possible Cause

The wired IR module cable is not being used.

Solution

Make sure that the wired IR module cable is being used.



Accessing Planar's Technical Support Website

Visit <http://www.planar.com/support> for the following support documents and resources:

- User Manual
- RS232 User Manual
- Touch screen drivers
- Standard warranties
- Planar support hotline number and email

Discontinued

Index

A

adjusting volume, 20
advanced settings menu, 28
audio menu, 26
avoiding temporary image retention, 4

C

cleaning the display, 6
codes, error, 66
color subsampling, 57
control, external, 53

D

dimensions, 60
display
 installing, 10

E

error codes, 66
external control, 53

I

image adjust menu, 23
information menu, 42
input source
 selecting, 20
inputs and view menu, 22
installation
 of LCD, 10
 safety precautions, 3
introduction, 1
IR codes, using, 16
IR commands
 for Planar QE, 16
 protocol, 16
IR not working, 69

L

LCD
 installation, 10
locking, 18

M

menus
 advanced settings, 28
 audio, 26
 image adjust, 23
 information, 42
 inputs and views, 22
 using, 21

N

navigating menus, 21
normal usage guidelines, 5

O

osd menus, 18, 21
 unlocking, 18

P

package contents, 7
Planar QE display
 troubleshooting via error codes, 66

R

recommended usage, 4
remote control
 using, 15

S

- safety
 - during installation, 3
 - information, 2
 - precautions, 2
 - precautions during use, 4
 - selecting input source, 20
 - service plans, ii
 - signal compatibility, 54
 - specifications, 58
 - subsampling
 - color, 57
 - supported timings, 54
-

T

- temporary image retention
 - avoiding, 4
 - definition, 4
 - timings, 54
 - TIR *see temporary image retention*
 - troubleshooting, 66
 - during installation, 66
 - error codes in Planar QE, 66
 - symptoms, 67
 - turning off the displays, 19
 - turning on the displays, 19
-

U

- using the remote, 15
-

V

- volume, 20
-

W

- warranty
 - information, ii

Planar Systems, Inc.

Customer Service

24x7 Online Technical Support: www.planar.com/support

1195 NW Compton Drive

Beaverton, OR 97006-1992

Tel: 1-866-PLANAR1 (866-752-6271), +1 503-748-5899 outside the United States

Hours: 24 hours a day, 7 days a week

© 01/01/2020 Planar Systems, Inc.

Planar is a registered trademark of Planar Systems, Inc. Other brands and names are the property of their respective owners. Technical information in this document is subject to change without notice.

020-1320-01A